

# Precision $W$ and $Z$ cross sections and the first measurement of the $W$ -boson mass with ATLAS

Jan Kretzschmar, University of Liverpool  
Seminar at UCL

27.01.2017



# The Large Hadron Collider & ATLAS

The highest Energy Collider ever built  
ATLAS one of the large experiments

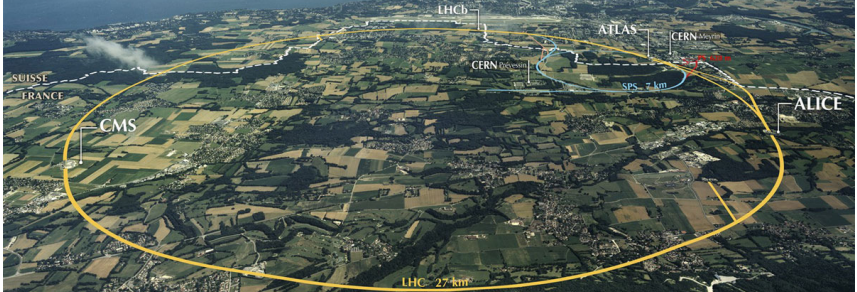

Successfully collided protons at 7 TeV and 8 TeV in 2010-2012 (Run 1)  
Since 2015 protons collide at 13 TeV (Run 2)

# The ATLAS Physics Menu

Large variety of searches and measurements

## Standard Model Production Cross Section Measurements

Status: August 2016

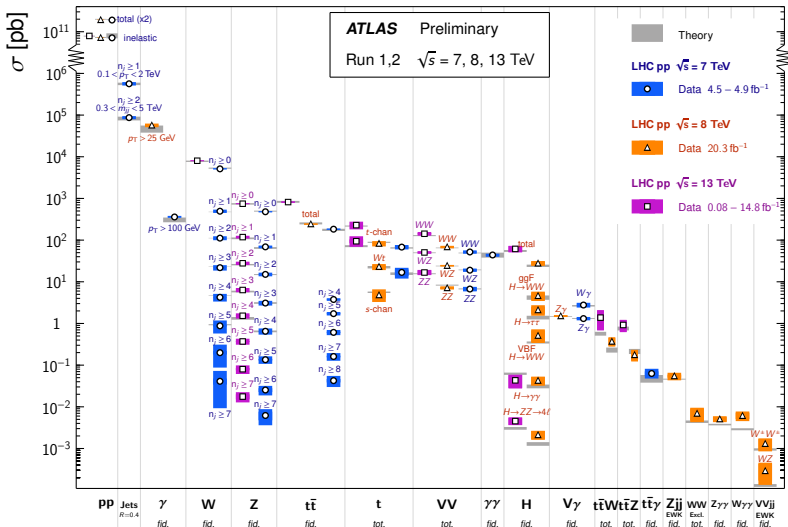



# LHC: A $W$ and $Z$ “Factory”

- ▶  $W$  and  $Z$  massive gauge bosons of the electro-weak  $SU(2)_L \times U(1)_Y$  symmetry, broken spontaneously by the Higgs mechanism
- ▶ Leptonic decays  $Z \rightarrow \ell\ell$  and  $W \rightarrow \ell\nu$  leave a unique signature at a hadron collider
- ▶ High integrated luminosity delivered by LHC means more  $Z \rightarrow \ell\ell$  and  $W \rightarrow \ell\nu$  events than any collider before have been produced
- ▶ ATLAS so far recorded  $> 10$  million  $Z \rightarrow \ell\ell$  and  $> 100$  million  $W \rightarrow \ell\nu$  events

July 2010

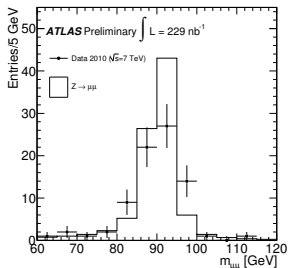

# LHC: A $W$ and $Z$ “Factory”

- ▶  $W$  and  $Z$  massive gauge bosons of the electro-weak  $SU(2)_L \times U(1)_Y$  symmetry, broken spontaneously by the Higgs mechanism
- ▶ Leptonic decays  $Z \rightarrow \ell\ell$  and  $W \rightarrow \ell\nu$  leave a unique signature at a hadron collider
- ▶ High integrated luminosity delivered by LHC means more  $Z \rightarrow \ell\ell$  and  $W \rightarrow \ell\nu$  events than any collider before have been produced
- ▶ ATLAS so far recorded  $> 10$  million  $Z \rightarrow \ell\ell$  and  $> 100$  million  $W \rightarrow \ell\nu$  events

July 2010

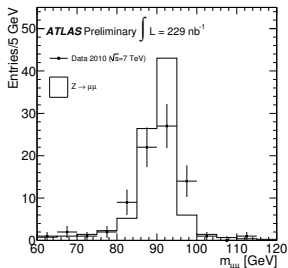

Full 2010 data

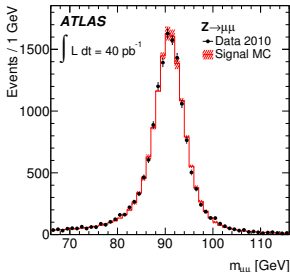

# LHC: A $W$ and $Z$ “Factory”

- ▶  $W$  and  $Z$  massive gauge bosons of the electro-weak  $SU(2)_L \times U(1)_Y$  symmetry, broken spontaneously by the Higgs mechanism
- ▶ Leptonic decays  $Z \rightarrow \ell\ell$  and  $W \rightarrow \ell\nu$  leave a unique signature at a hadron collider
- ▶ High integrated luminosity delivered by LHC means more  $Z \rightarrow \ell\ell$  and  $W \rightarrow \ell\nu$  events than any collider before have been produced
- ▶ ATLAS so far recorded  $> 10$  million  $Z \rightarrow \ell\ell$  and  $> 100$  million  $W \rightarrow \ell\nu$  events

July 2010

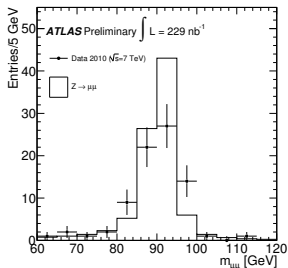

Full 2010 data

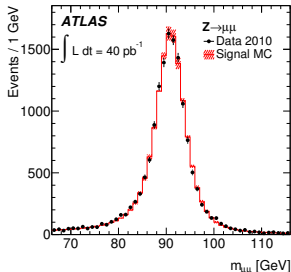

Full 2011 data

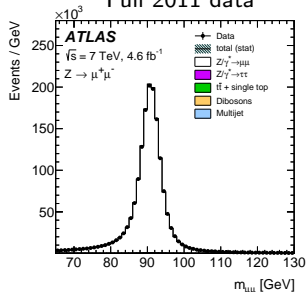

# LHC: A $W$ and $Z$ “Factory”

- ▶  $W$  and  $Z$  massive gauge bosons of the electro-weak  $SU(2)_L \times U(1)_Y$  symmetry, broken spontaneously by the Higgs mechanism
- ▶ Leptonic decays  $Z \rightarrow \ell\ell$  and  $W \rightarrow \ell\nu$  leave a unique signature at a hadron collider
- ▶ High integrated luminosity delivered by LHC means more  $Z \rightarrow \ell\ell$  and  $W \rightarrow \ell\nu$  events than any collider before have been produced
- ▶ ATLAS so far recorded  $> 10$  million  $Z \rightarrow \ell\ell$  and  $> 100$  million  $W \rightarrow \ell\nu$  events

Full 2012 data

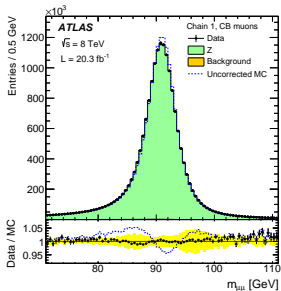



# LHC: A $W$ and $Z$ “Factory”

- ▶  $W$  and  $Z$  massive gauge bosons of the electro-weak  $SU(2)_L \times U(1)_Y$  symmetry, broken spontaneously by the Higgs mechanism
- ▶ Leptonic decays  $Z \rightarrow \ell\ell$  and  $W \rightarrow \ell\nu$  leave a unique signature at a hadron collider
- ▶ High integrated luminosity delivered by LHC means more  $Z \rightarrow \ell\ell$  and  $W \rightarrow \ell\nu$  events than any collider before have been produced
- ▶ ATLAS so far recorded  $> 10$  million  $Z \rightarrow \ell\ell$  and  $> 100$  million  $W \rightarrow \ell\nu$  events

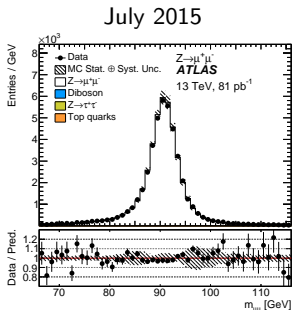
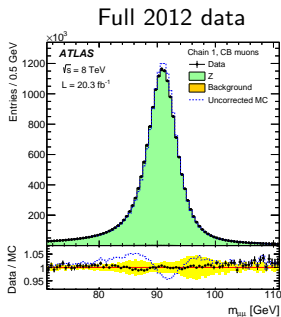

# LHC: A $W$ and $Z$ “Factory”

- ▶  $W$  and  $Z$  massive gauge bosons of the electro-weak  $SU(2)_L \times U(1)_Y$  symmetry, broken spontaneously by the Higgs mechanism
- ▶ Leptonic decays  $Z \rightarrow \ell\ell$  and  $W \rightarrow \ell\nu$  leave a unique signature at a hadron collider
- ▶ High integrated luminosity delivered by LHC means more  $Z \rightarrow \ell\ell$  and  $W \rightarrow \ell\nu$  events than any collider before have been produced
- ▶ ATLAS so far recorded  $> 10$  million  $Z \rightarrow \ell\ell$  and  $> 100$  million  $W \rightarrow \ell\nu$  events

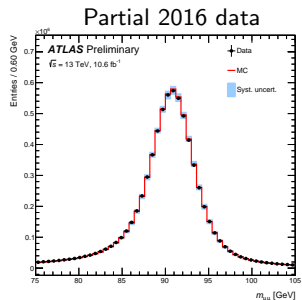
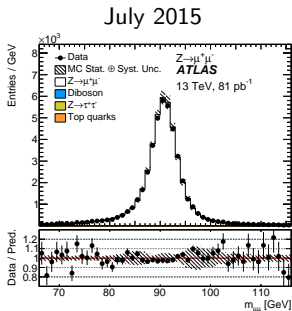
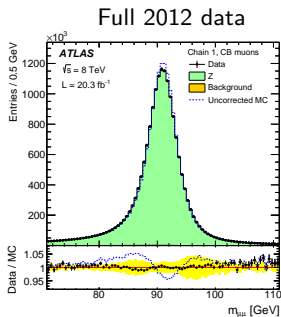

# $W$ and $Z$ Bosons Physics at LHC

- ▶  $W^\pm$  and  $Z/\gamma^*$  bosons produced in Drell-Yan process
- ▶ Measurements primarily require lepton detection — very high experimental precision can be achieved
- ▶ **Precision cross-section measurement:** probe of strong interaction and the **proton structure (Parton Distribution Functions, PDFs)**, [arXiv:1612.03016](https://arxiv.org/abs/1612.03016):
  - ▶ What can be learned beyond  $ep$  scattering?
- ▶ **First measurement of the  $W$ -boson mass:** test **consistency of the Standard Model** and constrain Beyond-SM physics, [arXiv:1701.07240](https://arxiv.org/abs/1701.07240):
  - ▶ Can we go beyond Tevatron measurements of  $\sim 19 - 23$  MeV uncertainty?

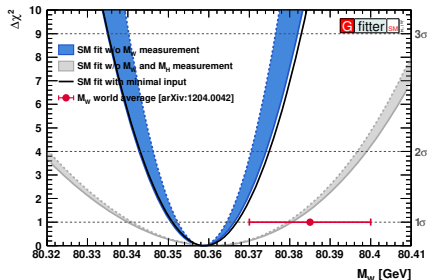
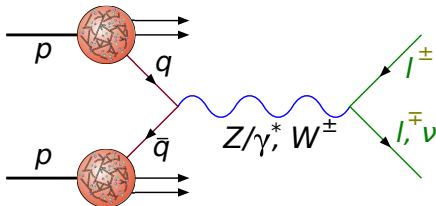

# Predictions for $W$ and $Z$ Production in Hadron Collisions

- ▶ Cross section calculation with hadrons factorises in
  - ▶ *Matrix element* calculation, arranged in a perturbative series in  $\alpha_s$ : Leading order (LO), Next-to-leading order (NLO), NNLO, ...
  - ▶ *Parton distribution functions* (PDFs)
- ▶  $W \rightarrow \ell\nu$  and  $Z \rightarrow \ell\ell$  known to NLO since  $\sim 1980$ , initial NNLO results date back to early 1990's, fully differential calculation since 2006 in FEWZ and DYNNLO
- ▶ Next level of complexity mastered in last years ( $gg \rightarrow H$  at N<sup>3</sup>LO and  $2 \rightarrow 2$  processes like  $Z$ +jet at NNLO), but absolute cross sections predicted to  $\lesssim 1\%$  precision is still unique in hadron collisions
- ▶ Beyond fixed order QCD: higher order EWK ( $\alpha_s^2 \sim \alpha$ ) and resummation

$$d\sigma = \int dx_1 dx_2 f_i(x_1) f_j(x_2) d\sigma_{ij}(x_1, x_2) F_J (1 + \mathcal{O}(\Lambda_{\text{QCD}}/Q))$$

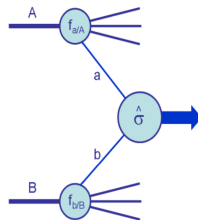
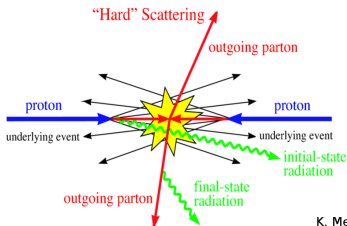

K. Melnikov, QCD@LHC 2016

- ▶ DIS experiments at SLAC in 1969 ( $ep \rightarrow eX$ ) found cross section to be  $\sim$ independent of momentum transfer  $Q^2$ : proton consists of point-like *quarks*
- ▶ Further precise measurements, e.g. at HERA  $ep$  collider, over wide range of  $x$ ,  $Q^2$ : neutral current ( $\gamma^*$  exchange) constrains  $\sum e_q^2(q + \bar{q})$ , at low momentum fraction  $x$  strong *scaling violations* due to gluons
- ▶ A big unknown is the flavour decomposition of light-quark sea at  $x < 10^{-2}$ :  $\bar{u} \sim \bar{d}$ , strange suppressed?

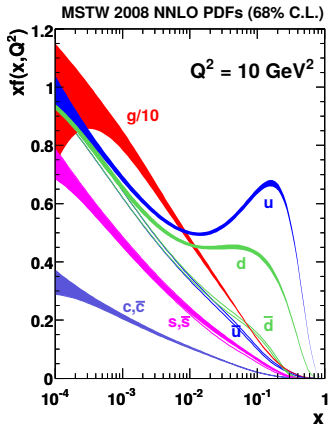
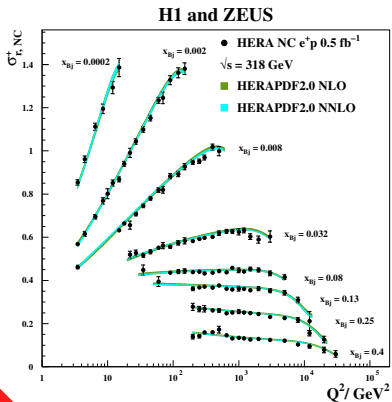

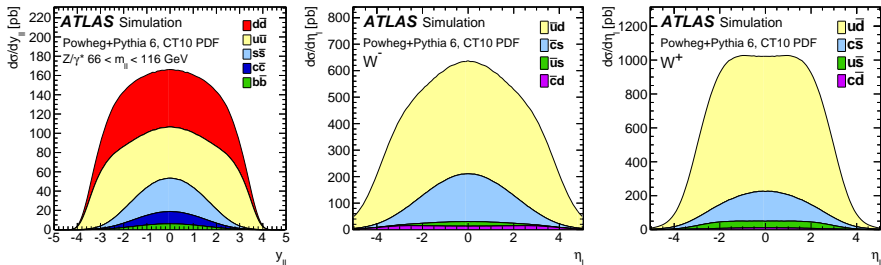

- ▶ At LO cross sections determined by sum of different  $q\bar{q}$  combinations weighted by different electro-weak couplings and CKM elements for  $W^\pm$
- ▶ Different composition of flavours than constrained by the HERA dataset:
  - ▶  $W$ -boson mass measurement subject to significant PDF uncertainties due to large  $cs$  component
  - ▶ Precise cross section measurements improves our knowledge of the proton structure
  - ▶ 2010 ATLAS  $W, Z$  data suggested a larger than expected strange-quark contribution:  $r_s = \bar{s}/\bar{d} \approx 1$

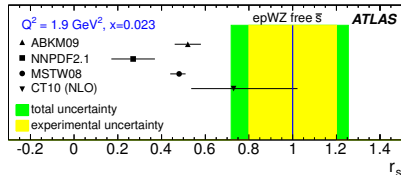

- ▶ W-boson mass related to other SM parameters

$$m_W^2 \sin^2 \theta_W = \frac{\pi\alpha}{\sqrt{2}G_F}(1 + \Delta r)$$

- ▶ Prediction sensitive to loop-corrections: QED, top, H, ... BSM?
- ▶  $m_W$  currently measured to  $\pm 15$  MeV and predicted to  $\pm 8$  MeV; many other EWK parameters measured far better than SM prediction
- ▶ Current Tevatron results use  $\sim 100,000$  Z and  $1 - 2M$  W events (+  $J/\psi \rightarrow \mu\mu$ )
- ▶ Already 2011 ATLAS sample has  $\sim 2M$  Z and  $\sim 20M$  W events

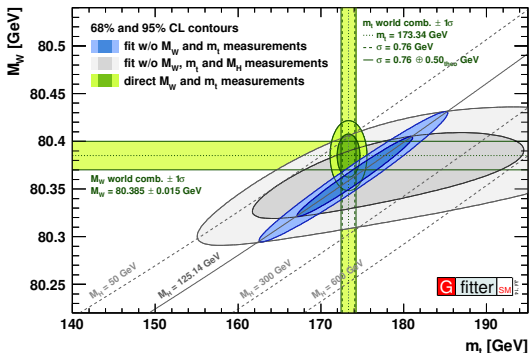

- ▶ W-boson mass related to other SM parameters

$$m_W^2 \sin^2 \theta_W = \frac{\pi\alpha}{\sqrt{2}G_F}(1 + \Delta r)$$

- ▶ Prediction sensitive to loop-corrections: QED, top, H, ... BSM?
- ▶  $m_W$  currently measured to  $\pm 15$  MeV and predicted to  $\pm 8$  MeV; many other EWK parameters measured far better than SM prediction
- ▶ Current Tevatron results use  $\sim 100,000$  Z and  $1 - 2M$  W events (+  $J/\psi \rightarrow \mu\mu$ )
- ▶ Already 2011 ATLAS sample has  $\sim 2M$  Z and  $\sim 20M$  W events

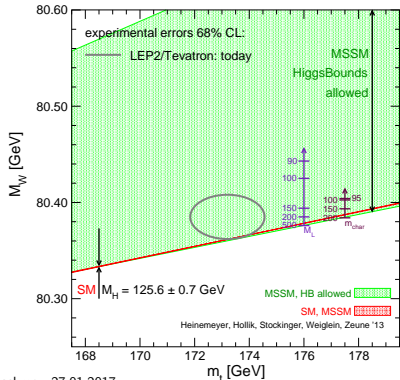
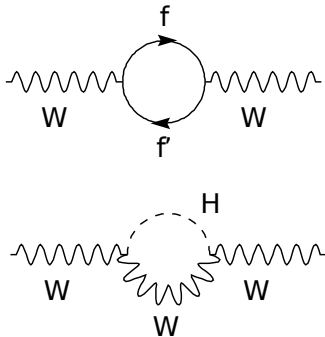



- ▶ W-boson mass related to other SM parameters

$$m_W^2 \sin^2 \theta_W = \frac{\pi\alpha}{\sqrt{2}G_F}(1 + \Delta r)$$

- ▶ Prediction sensitive to loop-corrections: QED, top, H, ... BSM?
- ▶  $m_W$  currently measured to  $\pm 15$  MeV and predicted to  $\pm 8$  MeV; many other EWK parameters measured far better than SM prediction
- ▶ Current Tevatron results use  $\sim 100,000$  Z and  $1 - 2M$  W events (+  $J/\psi \rightarrow \mu\mu$ )
- ▶ Already 2011 ATLAS sample has  $\sim 2M$  Z and  $\sim 20M$  W events

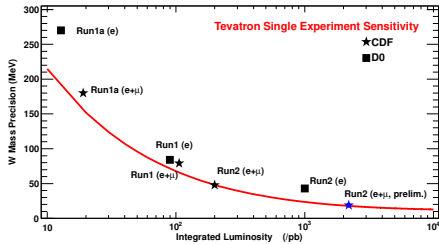
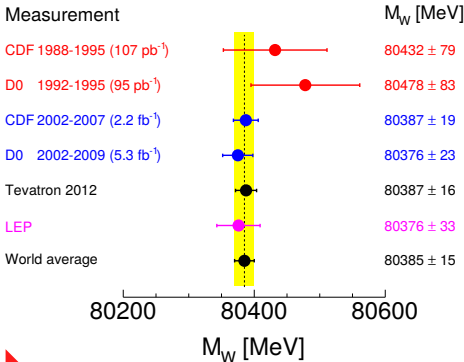



# Data sample

- ▶ Both analyses presented use the 2011 data set of  $4.6 \text{ fb}^{-1}$ :
  - ▶ Understanding of detector performance and analysis takes time!
  - ▶ Moderate pileup: “only” 9 simultaneous  $pp$  interactions on average
- ▶ LHC and ATLAS performance has been exceptional in the last years: none of the measurements presented are (directly) limited by data statistics, but detector systematics can typically be improved with larger calibration samples
- ▶ Analyse simultaneously both the electron- and muon-decay channels:  
 $W \rightarrow e\nu$ ,  $W \rightarrow \mu\nu$ ,  $Z \rightarrow ee$ ,  $Z \rightarrow \mu\mu$   
⇒ critical to gain confidence in results and achieve the ultimate precision

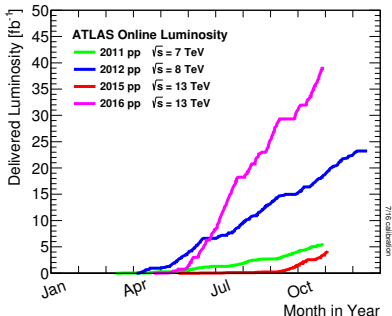
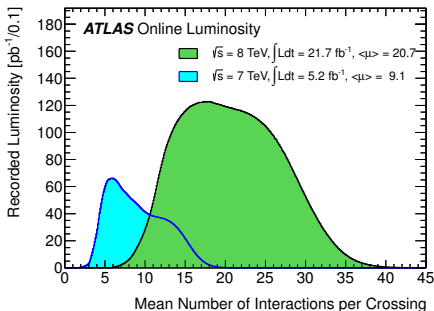

# A $W \rightarrow e\nu$ candidate

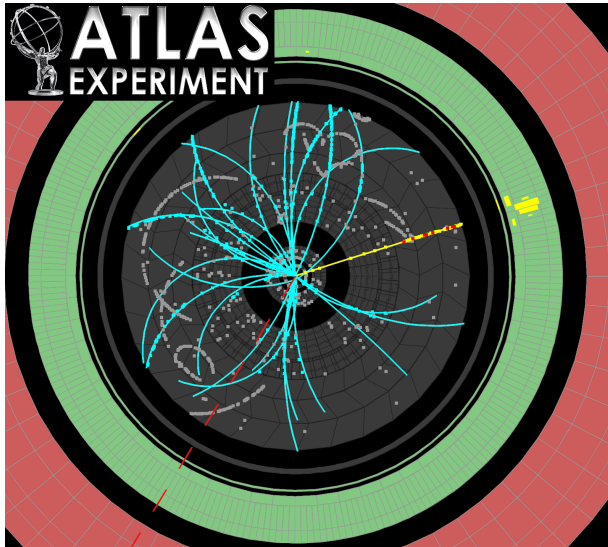

Run Number: 152409, Event Number: 5966801

Date: 2010-04-05 06:54:50 CEST

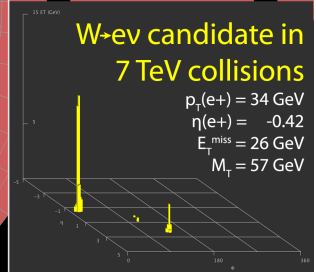
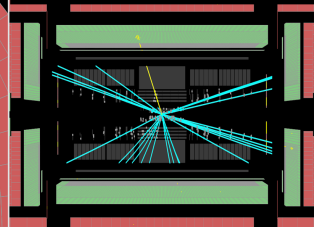

# A $Z \rightarrow \mu\mu$ candidate

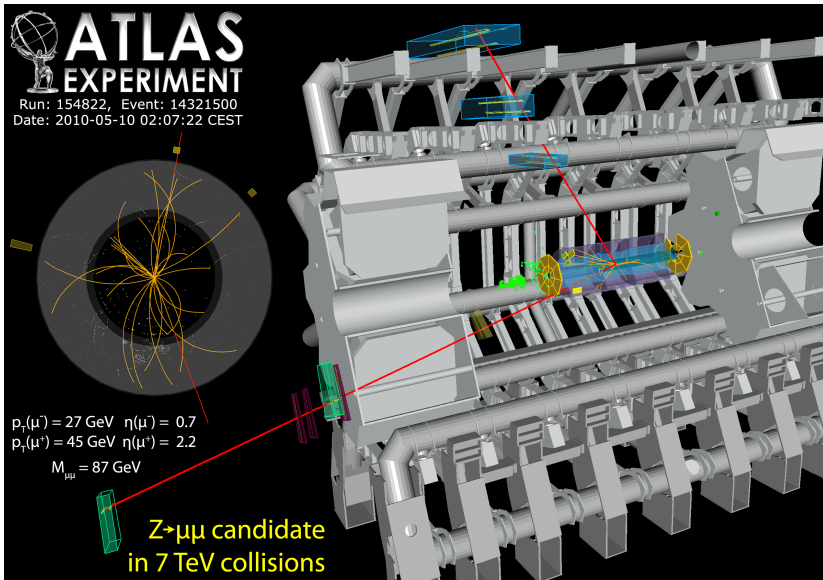

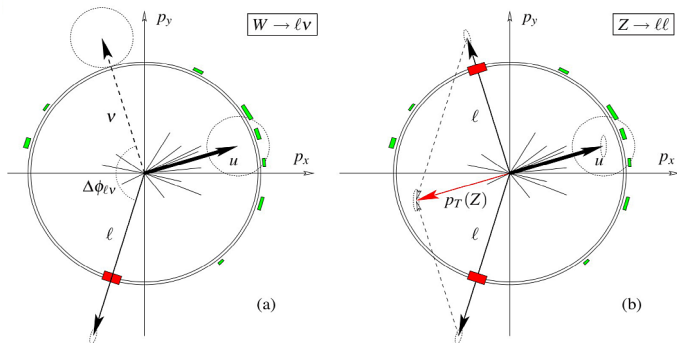

- ▶  $W \rightarrow \ell\nu$ :
  - ▶ one isolated lepton ( $e$  or  $\mu$ ) with  $p_T^\ell > 25$  GeV and  $|\eta^\ell| \lesssim 2.4$
  - ▶ remainder of the event: “hadronic recoil”  $\vec{u}_T$  ( $u_T < 30$  GeV for  $W$  mass)
  - ▶ neutrino inferred using  $\vec{p}_T^{\text{miss}} = -(\vec{p}_T^\ell + \vec{u}_T) > 25$  GeV
  - ▶ transverse mass  $m_T = \sqrt{2p_T^\ell p_T^{\text{miss}}(1 - \cos \Delta\phi)} > 40$  GeV
- ▶  $Z \rightarrow \ell\ell$ : two isolated leptons ( $ee$  or  $\mu\mu$ ) with  $p_T^\ell > 20$  GeV and  $|\eta^\ell| \lesssim 2.4$ , invariant mass  $m_{\ell\ell} = 46 - 150$  GeV
- ▶ Selection for cross-section measurements, for  $W$ -mass slightly tighter criteria applied

## Cross-section analysis

- ▶ Binned event yields ( $N$ ) corrected for background ( $B$ ), efficiencies and migrations ( $C = N_{\text{rec}}^{\text{MC}} / N_{\text{gen}}^{\text{MC}}$ ) to obtain (differential) cross sections

$$\sigma^{\text{fid}} = \frac{N - B}{C \cdot \mathcal{L}_{\text{int}}}$$

- ▶ Combination of  $e$  and  $\mu$  channels
- ▶ Comparison to NNLO QCD + NLO EWK predictions, QCD analysis  $\rightarrow$  new PDF set

## W-boson mass analysis

- ▶ Simulated events reweighted best theory of  $W$  production and decay and a series of different  $m_W$  values
- ▶ Fit to sensitive distributions ( $p_T^\ell$ ,  $m_T$ ) to determine best  $m_W$  value
- ▶ Initial blinding of  $m_W$  by an unknown, common offset

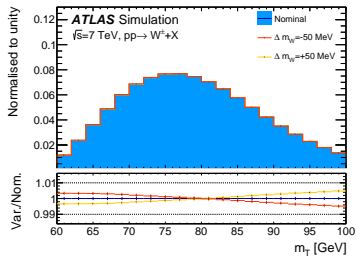
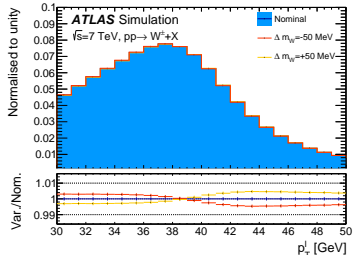

**Common:** detector performance needs to be understood at very high level





- ▶ Electron detection complicated by large amount of material in the detector and significant background from jets
- ▶ Efficiency controlled in several steps using “tag-and-probe”: relies mostly on  $Z \rightarrow \ell\ell$  events selected with looser criteria on one leg
- ▶ Simulation not perfect  $\rightarrow$  correct simulation double-differentially in  $(\eta^\ell, p_T^\ell)$  by measured  $\epsilon_{\text{data}}/\epsilon_{\text{MC}}$ , known to typically  $\sim 0.2 - 1\%$  in relevant range  $p_T^\ell > 25$  GeV
- ▶ Important to control  $p_T^\ell$ -dependent slopes for  $m_W$ , directly relevant as systematics for cross-section measurement

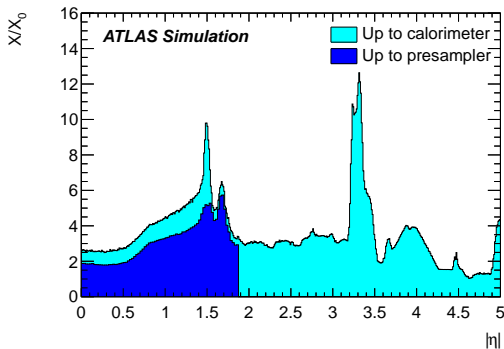

- ▶ Electron detection complicated by large amount of material in the detector and significant background from jets
- ▶ Efficiency controlled in several steps using “tag-and-probe”: relies mostly on  $Z \rightarrow \ell\ell$  events selected with looser criteria on one leg
- ▶ Simulation not perfect  $\rightarrow$  correct simulation double-differentially in  $(\eta^\ell, p_T^\ell)$  by measured  $\epsilon_{\text{data}}/\epsilon_{\text{MC}}$ , known to typically  $\sim 0.2 - 1\%$  in relevant range  $p_T^\ell > 25$  GeV
- ▶ Important to control  $p_T^\ell$ -dependent slopes for  $m_W$ , directly relevant as systematics for cross-section measurement

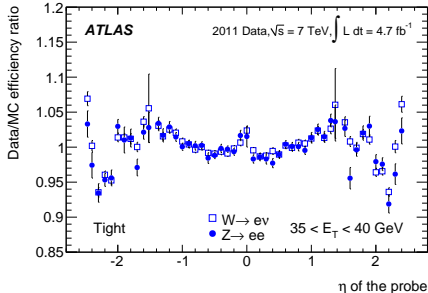
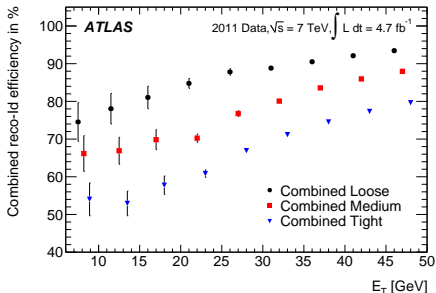

- ▶ Overall electron energy scale and resolution set to match the  $Z$ -boson parameters known precisely from LEP
- ▶ Understand possible non-linearities in  $Z \rightarrow W$  extrapolation from passive material: controlled with muons (MIPs), longitudinal shower development of electrons and photons
- ▶ Precision of  $10^{-4}$  equals  $\pm 8$  MeV on  $m_W$ : reached, secondary effect for cross-section measurement

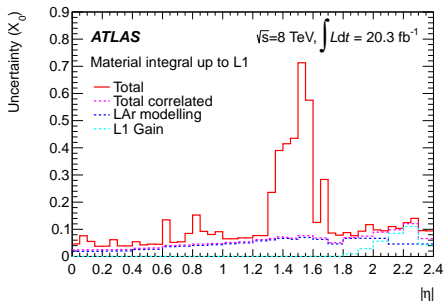
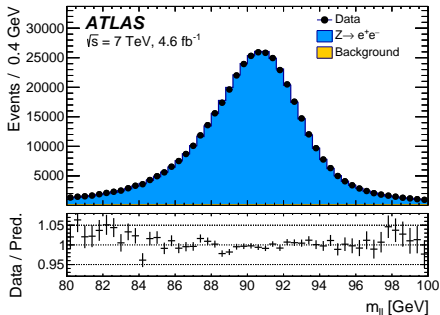

- ▶ Overall electron energy scale and resolution set to match the Z-boson parameters known precisely from LEP
- ▶ Understand possible non-linearities in  $Z \rightarrow W$  extrapolation from passive material: controlled with muons (MIPs), longitudinal shower development of electrons and photons
- ▶ Precision of  $10^{-4}$  equals  $\pm 8$  MeV on  $m_W$ : reached, secondary effect for cross-section measurement

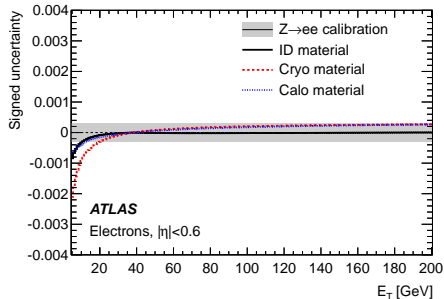
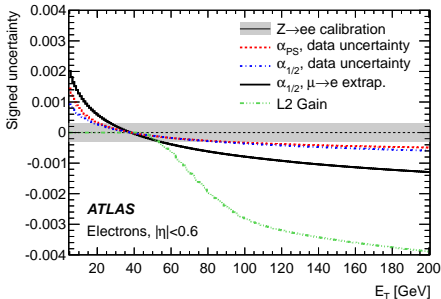

# Muon Calibration

- ▶ Overall momentum scale and resolution set to match the  $Z$ -boson parameters
- ▶ Non-linearities controlled from  $Z \rightarrow \mu\mu$  sample
- ▶ Reached the  $10^{-4}$  precision required for  $W$  mass
- ▶ Rotational detector deformations and flaws in alignment procedure can introduce charge-dependent sagitta bias  $\delta$  – best controlled with  $E/p$  in  $W^\pm \rightarrow e^\pm \nu$  events:

$$p_T^{\text{corr}} = \frac{p_T}{1 + q \cdot \delta(\eta, \phi) \cdot p_T}$$

- ▶ Sagitta effect important to control  $W^+/W^-$  mass and cross-section ratio

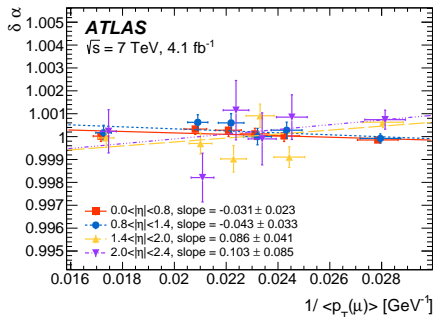
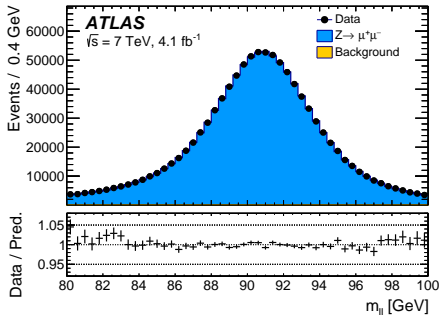

# Muon Calibration

- ▶ Overall momentum scale and resolution set to match the  $Z$ -boson parameters
- ▶ Non-linearities controlled from  $Z \rightarrow \mu\mu$  sample
- ▶ Reached the  $10^{-4}$  precision required for  $W$  mass
- ▶ Rotational detector deformations and flaws in alignment procedure can introduce charge-dependent sagitta bias  $\delta$  – best controlled with  $E/p$  in  $W^\pm \rightarrow e^\pm \nu$  events:

$$p_T^{\text{corr}} = \frac{p_T}{1 + q \cdot \delta(\eta, \phi) \cdot p_T}$$

- ▶ Sagitta effect important to control  $W^+/W^-$  mass and cross-section ratio

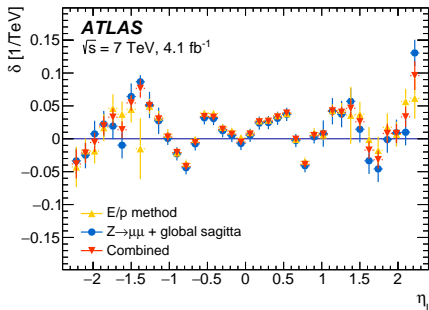
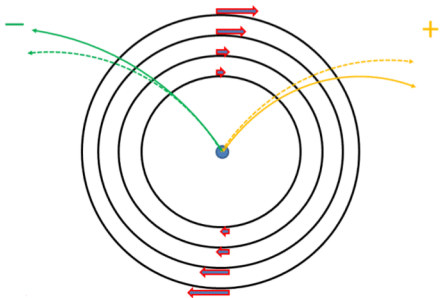

# Hadronic Recoil Calibration

- ▶ Hadronic recoil reconstructed from all calorimeter clusters in the event after removing cones around identified leptons & replacing by a “random” cone
- ▶ Affected by pileup and underlying event, all of which is not necessarily well modelled
- ▶ Reweighting to equalise event activity, scale and resolution calibration using projections parallel and transverse to Z direction

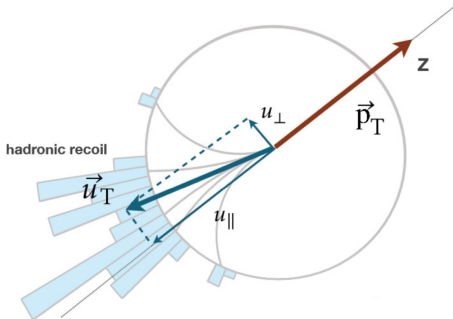
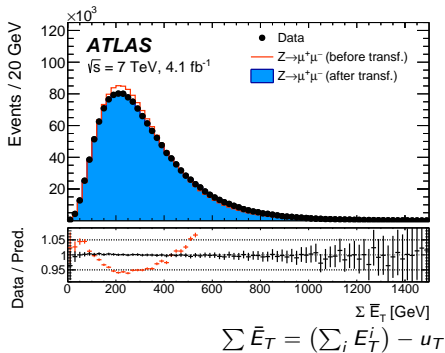

# Backgrounds

- ▶ Very small background for  $Z \rightarrow ee$  and  $Z \rightarrow \mu\mu$ :  
 $\sim 0.2\%$  at  $Z$  peak and a few % in off-peak region
- ▶ Background to  $W \rightarrow \ell\nu$  more difficult:
  - ▶  $W \rightarrow \tau\nu$  and  $Z \rightarrow \ell\ell$  taken from MC – need to account for correct modelling of veto-efficiency for  $W$ -mass analysis!
  - ▶ Multi-jet background not large, but determination using a data template hard to control – done via extrapolation procedure

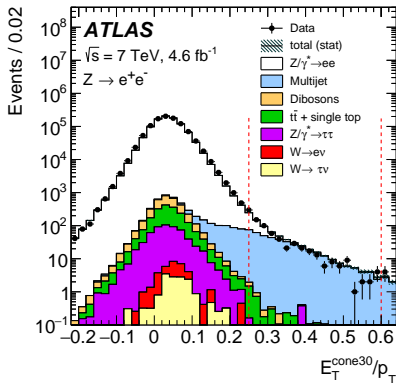
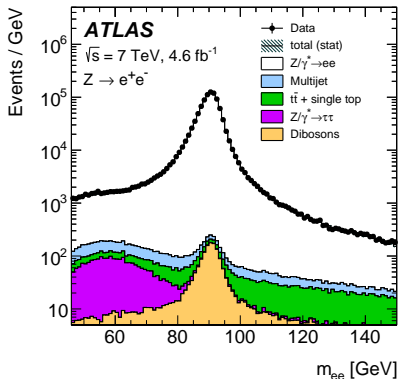



# Backgrounds

- ▶ Very small background for  $Z \rightarrow ee$  and  $Z \rightarrow \mu\mu$ :  
~ 0.2% at  $Z$  peak and a few % in off-peak region
- ▶ Background to  $W \rightarrow \ell\nu$  more difficult:
  - ▶  $W \rightarrow \tau\nu$  and  $Z \rightarrow \ell\ell$  taken from MC – need to account for correct modelling of veto-efficiency for  $W$ -mass analysis!
  - ▶ Multi-jet background not large, but determination using a data template hard to control – done via extrapolation procedure

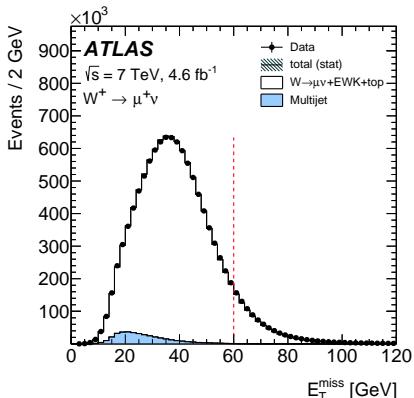
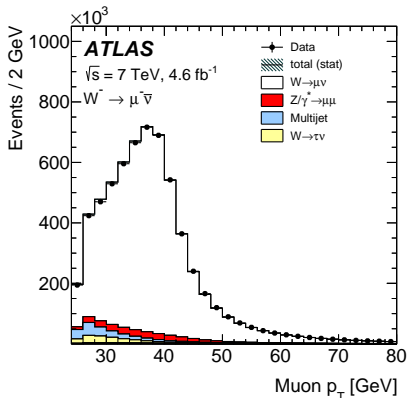

# Backgrounds

- ▶ Very small background for  $Z \rightarrow ee$  and  $Z \rightarrow \mu\mu$ :  
 $\sim 0.2\%$  at  $Z$  peak and a few % in off-peak region
- ▶ Background to  $W \rightarrow \ell\nu$  more difficult:
  - ▶  $W \rightarrow \tau\nu$  and  $Z \rightarrow \ell\ell$  taken from MC – need to account for correct modelling of veto-efficiency for  $W$ -mass analysis!
  - ▶ Multi-jet background not large, but determination using a data template hard to control – done via extrapolation procedure

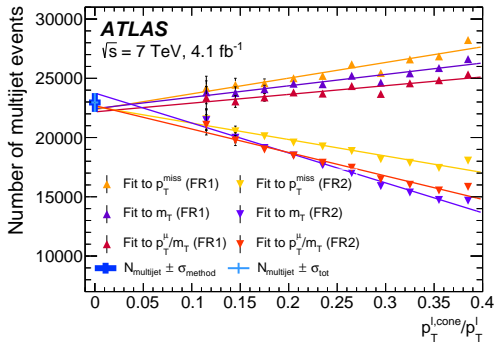
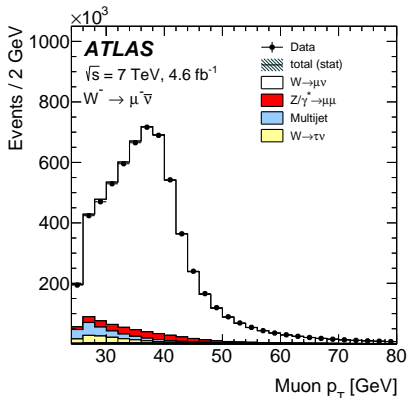



## Integrated cross-section results and combination

- ▶ Integrated cross sections measured to 0.6 – 1.0% for  $W$  and 0.4% for  $Z$
- ▶ Overall correlated 1.8% luminosity uncertainty
- ▶ Combination interpreted as test of  $e - \mu$  universality: most precise test for on-shell  $W$ , “only” factor 2 worse than LEP for  $Z$

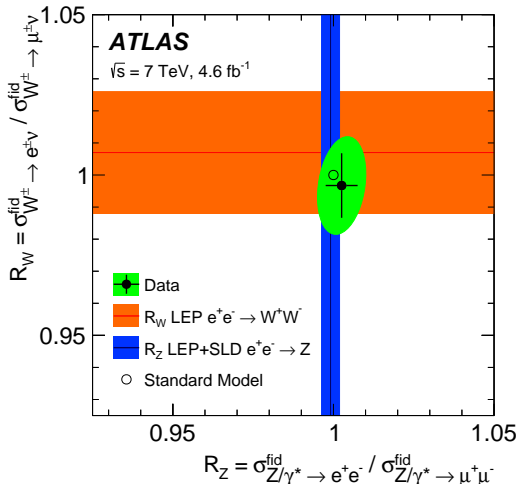

# Differential cross-section combination

- ▶ 105 measurement points:  $W^\pm$  as function of charged lepton rapidity  $|\eta^\ell|$ ,  $Z/\gamma^*$  as function of di-lepton rapidity  $|y_{\ell\ell}|$  and mass  $m_{\ell\ell}$
- ▶ Different detection challenges for electrons and muons
- ▶  $e - \mu$  combination to 61 final points including all correlations:  $\chi^2/\text{n.d.f.} = 59.5/53$

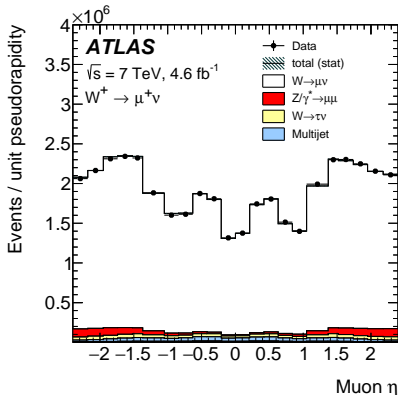
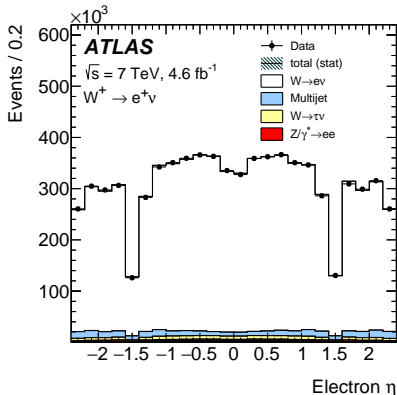

# Differential cross-section combination

- ▶ 105 measurement points:  $W^\pm$  as function of charged lepton rapidity  $|\eta^\ell|$ ,  $Z/\gamma^*$  as function of di-lepton rapidity  $|y_{\ell\ell}|$  and mass  $m_{\ell\ell}$
- ▶ Different detection challenges for electrons and muons
- ▶  $e - \mu$  combination to 61 final points including all correlations:  $\chi^2/\text{n.d.f.} = 59.5/53$

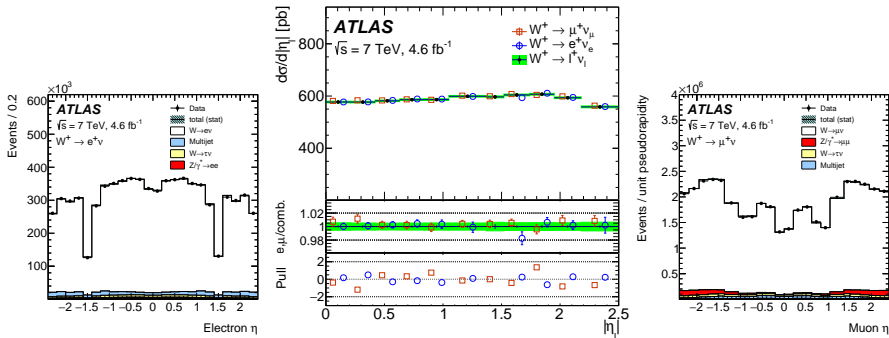

# Differential cross-section combination

- ▶ 105 measurement points:  $W^\pm$  as function of charged lepton rapidity  $|\eta^\ell|$ ,  $Z/\gamma^*$  as function of di-lepton rapidity  $|y_{\ell\ell}|$  and mass  $m_{\ell\ell}$
- ▶ Different detection challenges for electrons and muons
- ▶  $e - \mu$  combination to 61 final points including all correlations:  $\chi^2/\text{n.d.f.} = 59.5/53$

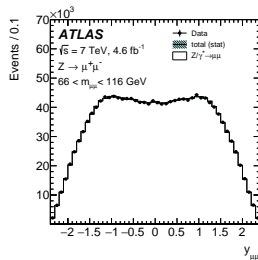
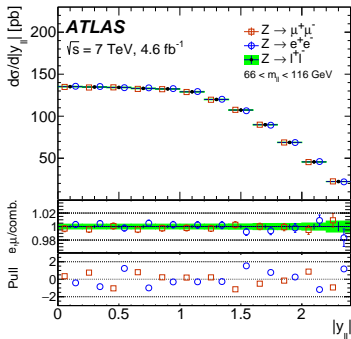
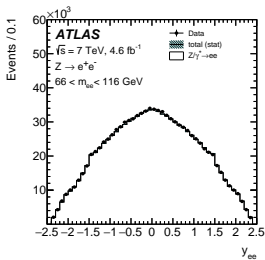

## Integrated cross section vs. Theory

- ▶ Interpretation of measurement in terms of PDFs relies on accurate theory calculations at NNLO QCD and NLO EWK
- ▶ Measured integrated fiducial cross sections more precise than most PDF sets:  $W^\pm$  well described,  $W/Z$  ratio systematically different

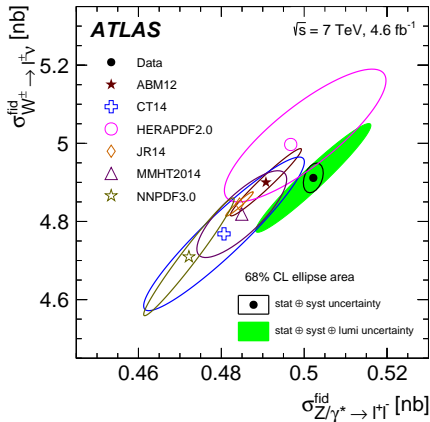
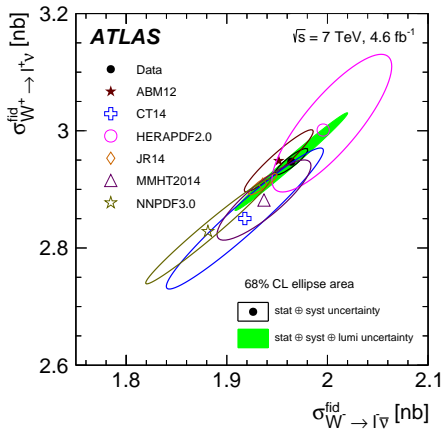



# Integrated cross section vs. Theory

- ▶ Interpretation of measurement in terms of PDFs relies on accurate theory calculations at NNLO QCD and NLO EWK
- ▶ Measured integrated fiducial cross sections more precise than most PDF sets:  $W^\pm$  well described,  $W/Z$  ratio systematically different

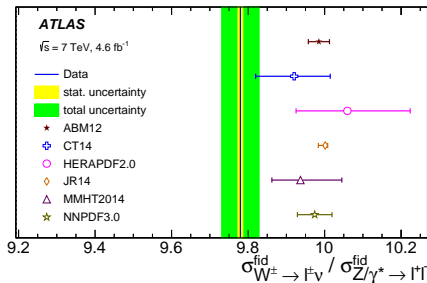
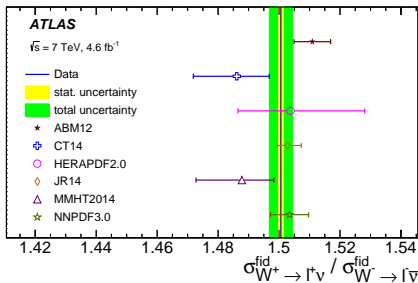

# Differential cross section vs. Theory

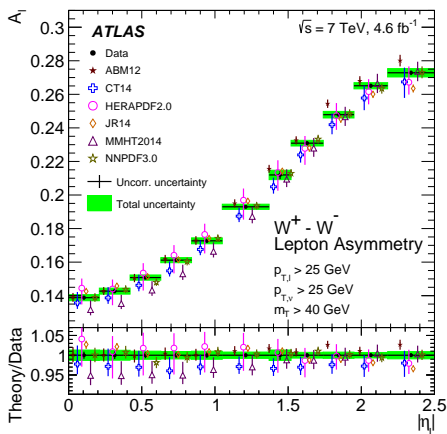
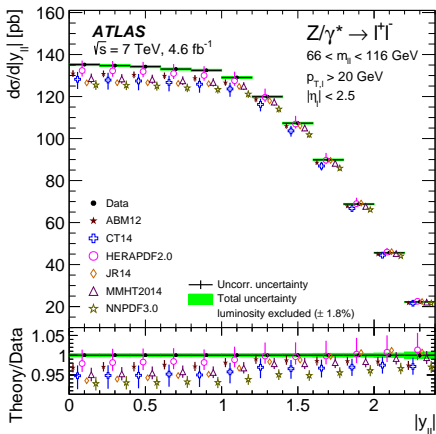

► Challenge for theory to describe the data at sub-percent level

# Differential cross section vs. Theory

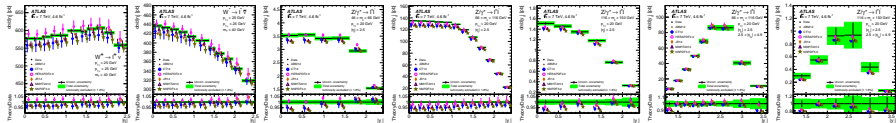

- ▶ Quantitative  $\chi^2$  analysis of theory/data agreement using all differential distributions: CT14 ( $\chi^2/\text{n.d.f.} = 103/61$ ) best, NNPDF3.0 ( $\chi^2/\text{n.d.f.} = 147/61$ ) worst
- ▶ Older CT10 gives  $\chi^2/\text{n.d.f.} = 101/61$  – used as baseline for  $W$  mass

Data set	n.d.f.	ABM12	CT14	MMHT14	NNPDF3.0	ATLAS-epWZ12
$W^+ \rightarrow \ell^+ \nu$	11	11 21	10 26	11 37	11 18	12 15
$W^- \rightarrow \ell^- \bar{\nu}$	11	12 20	8.9 27	8.1 31	12 19	7.8 17
$Z/\gamma^* \rightarrow \ell\ell$ ( $m_{\ell\ell} = 46 - 66$ GeV)	6	17 21	11 30	18 24	21 22	28 36
$Z/\gamma^* \rightarrow \ell\ell$ ( $m_{\ell\ell} = 66 - 116$ GeV)	12	24 51	16 66	20 116	14 109	18 26
Forward $Z/\gamma^* \rightarrow \ell\ell$ ( $m_{\ell\ell} = 66 - 116$ GeV)	9	7.3 9.3	10 12	12 13	14 18	6.8 7.5
$Z/\gamma^* \rightarrow \ell\ell$ ( $m_{\ell\ell} = 116 - 150$ GeV)	6	6.1 6.6	6.3 6.1	5.9 6.6	6.1 8.8	6.7 6.6
Forward $Z/\gamma^* \rightarrow \ell\ell$ ( $m_{\ell\ell} = 116 - 150$ GeV)	6	4.2 3.9	5.1 4.3	5.6 4.6	5.1 5.0	3.6 3.5
Correlated $\chi^2$		57 90	39 123	43 167	69 157	31 48
Total $\chi^2$	61	136 222	103 290	118 396	147 351	113 159

$\chi^2$  {with | without} uncertainties from PDF sets



# QCD fit analysis

- ▶ Use the final HERA II DIS data set and new ATLAS  $W$  and  $Z$  data to derive a new PDF set (ATLAS-epWZ16)
- ▶ NNLO QCD can describe data, nominal  $\chi^2 = 108/61$
- ▶  $W, Z$  predictions at half of the conventional scales  $\mu_r = \mu_f = 0.5m_{\ell\ell}$  improves fit  $\chi^2$  significantly  $\chi^2 = 85/61$
- ▶ QCD scale uncertainty and FEWZ-DYNNLO difference one of the dominating uncertainties in the interpretation

$\mu_r$	$\mu_f$	$\chi^2/\text{n.d.f.}$	
		Total	ATLAS
1	1	1321 / 1102	108 / 61
1/2	1/2	1297 / 1102	85 / 61
2	2	1329 / 1102	115 / 61
1	1/2	1307 / 1102	94 / 61
1	2	1312 / 1102	100 / 61
1/2	1	1304 / 1102	94 / 61
2	1	1321 / 1102	107 / 61

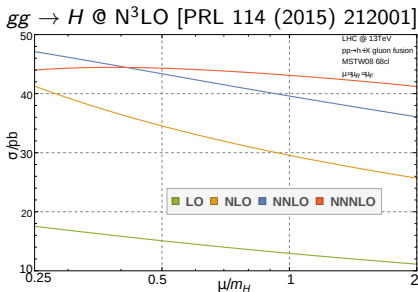

# The strange-quark density

- ▶ Confirmation of large strange-quark sea at low  $Q^2 = 1.9 \text{ GeV}^2$  and low  $x = 0.023$ :  
 $r_s = \bar{s}/\bar{d} = 1.19 \pm 0.07 \text{ (exp)} \pm 0.16 \text{ (fit + thy)}$
- ▶ Strange-quark density at low  $x$  of similar size as up-quark and down-quark
- ▶ Experimental uncertainty well below theory systematics
- ▶ Tension with most PDF sets due to neutrino-fixed target DIS di-muon data, which favours  $r_s \sim 0.5$ ?

	$r_s = \frac{s+\bar{s}}{2d}$	$R_s = \frac{s+\bar{s}}{u+d}$
Central value	1.19	1.13
Experimental data	$\pm 0.07$	$\pm 0.05$
Model ( $m_b, Q_{\min}^2, Q_0^2$ & $m_c$ )	$\pm 0.02$	$\pm 0.02$
Parameterization	+0.02 -0.10	+0.01 -0.06
$\alpha_s$	+0.00 -0.01	$\pm 0.01$
Beam energy $E_p$	$\pm 0.03$	+0.01 -0.02
EW corrections	$\pm 0.01$	$\pm 0.00$
QCD scales	+0.08 -0.10	+0.06 -0.07
FEWZ 3.1b2	+0.10	+0.08
Total uncertainty	+0.15 -0.16	$\pm 0.11$

ATLAS 2011 W, Z data + HERA II

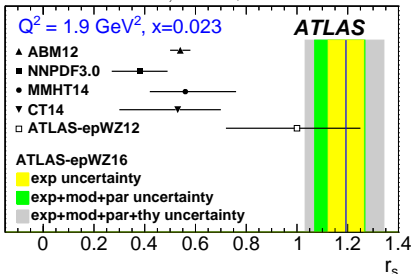

ATLAS 2010 W, Z data + HERA I

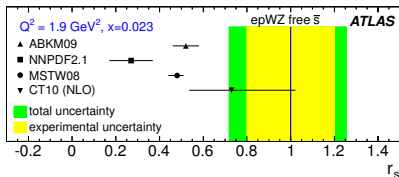



# Fully differential physics model for DY

- ▶ None of the standard MC generators provides a sufficiently precise description of production and decay of  $W^\pm \rightarrow \ell\nu$  and  $Z/\gamma^* \rightarrow \ell\ell$
- ▶ Factorisation of five-dimensional DY cross section allows reweighting

$$\frac{d\sigma}{dm_{\ell\ell} dp_{T,\ell\ell} dy_{\ell\ell}} \left[ 1 + \cos^2 \theta_{CS} + \sum_{i=0}^7 A_i(m_{\ell\ell}, p_{T,\ell\ell}, y_{\ell\ell}) f_i(\theta_{CS}, \phi_{CS}) \right]$$

- ▶ Higher order QED effects simulated, missing EWK pieces as systematics
- ▶  $m_{\ell\ell}$ : “simple” BW-resonance, scan  $m_W$ ...
- ▶  $y_{\ell\ell}$ , angular coefficients  $A_i$ : fixed-order NNLO QCD with CT10, validated by measured  $W, Z$  cross-sections and  $Z \rightarrow \ell\ell$  angular correlations (JHEP08(2016)159)
- ▶  $p_{T,\ell\ell}$ : needs resummation or parton shower

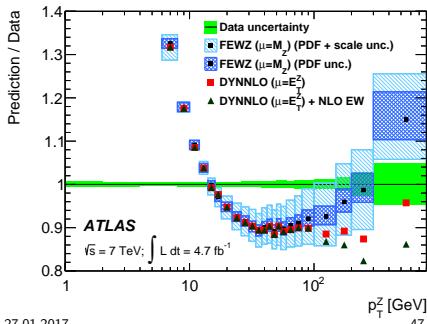

# Transverse momentum distribution

- ▶ Easy to measure for  $Z \rightarrow \ell\ell$ , hard for  $W \rightarrow \ell\nu \rightarrow$  tune on  $Z$ , predict  $W$
- ▶  $Z \rightarrow W$  translation: PDF and heavy-quark effects, large  $cs$  contribution to  $W$
- ▶ Advanced resummed prediction like DYRES, ResBos etc (NNLO + NNLL) fail — Pythia8 left as only working choice: validated by  $u_{||}^{\ell}$  distribution
- ▶ Perform variations on Pythia8: factorisation scale (separate for light and heavy quarks),  $m_c$ ,  $m_b$ , PDF in parton shower and matrix element

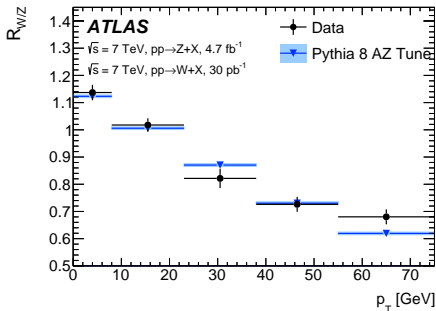
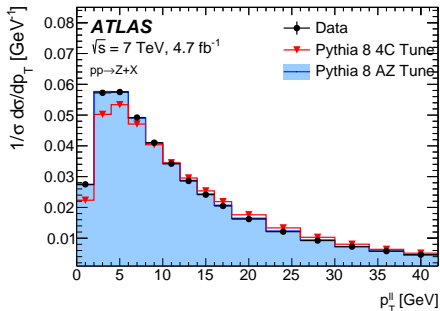



# Transverse momentum distribution

- ▶ Easy to measure for  $Z \rightarrow \ell\ell$ , hard for  $W \rightarrow \ell\nu \rightarrow$  tune on  $Z$ , predict  $W$
- ▶  $Z \rightarrow W$  translation: PDF and heavy-quark effects, large  $cs$  contribution to  $W$
- ▶ Advanced resummed prediction like DYRES, ResBos etc (NNLO + NNLL) fail — Pythia8 left as only working choice: validated by  $u_{\parallel}^{\ell}$  distribution
- ▶ Perform variations on Pythia8: factorisation scale (separate for light and heavy quarks),  $m_c$ ,  $m_b$ , PDF in parton shower and matrix element

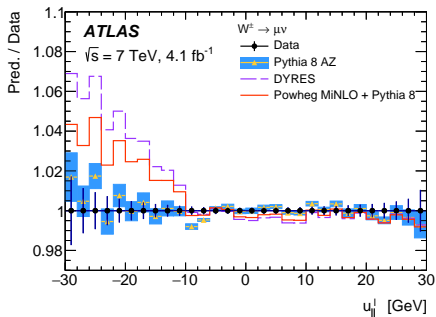
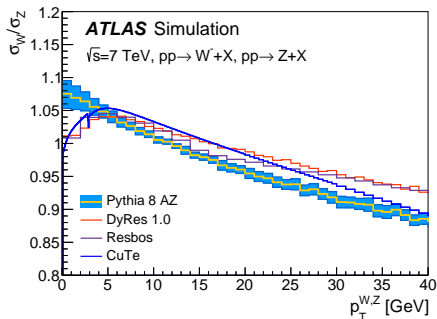

# Transverse momentum distribution

- ▶ Easy to measure for  $Z \rightarrow \ell\ell$ , hard for  $W \rightarrow \ell\nu \rightarrow$  tune on  $Z$ , predict  $W$
- ▶  $Z \rightarrow W$  translation: PDF and heavy-quark effects, large  $cs$  contribution to  $W$
- ▶ Advanced resummed prediction like DYRES, ResBos etc (NNLO + NNLL) fail — Pythia8 left as only working choice: validated by  $u_{\parallel}^{\ell}$  distribution
- ▶ Perform variations on Pythia8: factorisation scale (separate for light and heavy quarks),  $m_c$ ,  $m_b$ , PDF in parton shower and matrix element

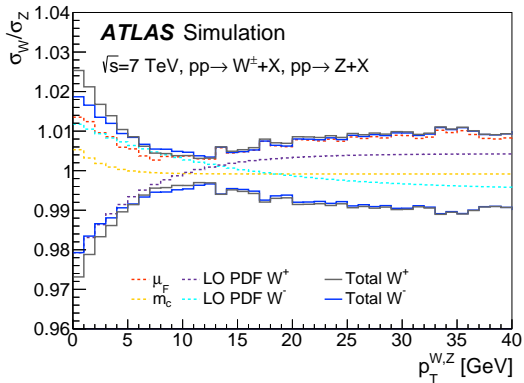

# W-like cross-checks with Z events

Extract Z-mass using W-like distributions of  $p_T^\ell$  and  $m_T$  as closure test  
 $\Rightarrow$  statistics dominated, ok at  $\sim 1.5\sigma$

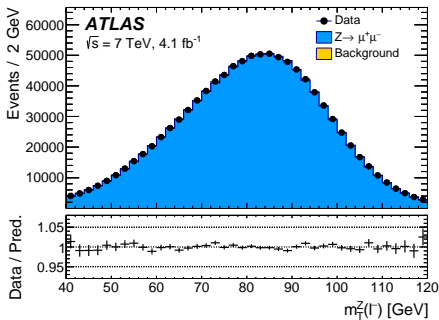
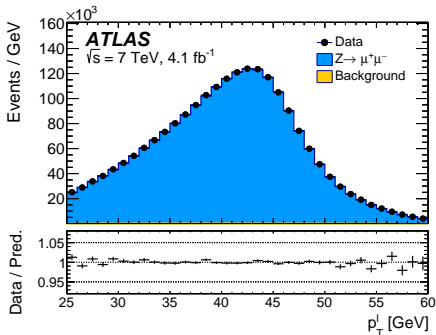
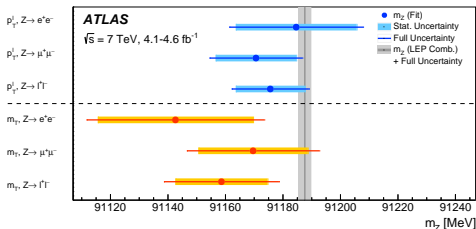

# W-boson mass fit distributions: $p_T^l$

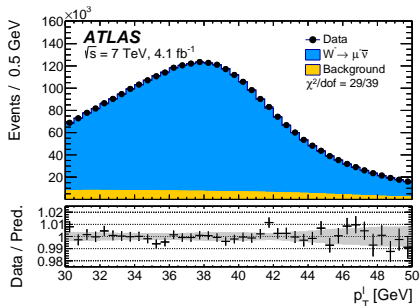
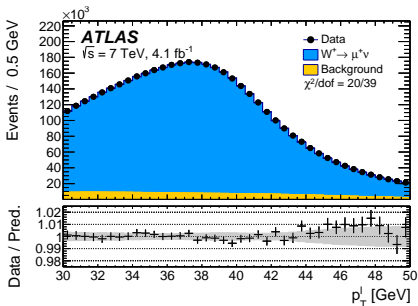
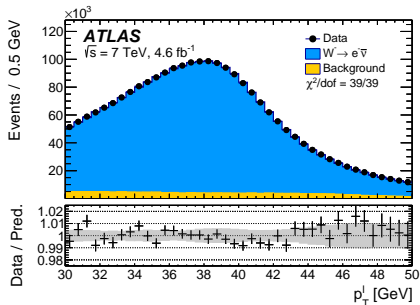
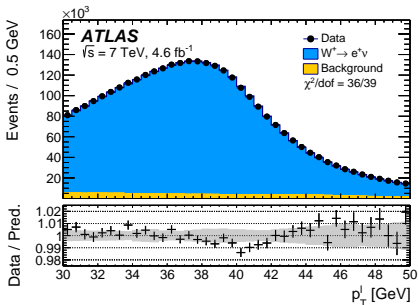

# W-boson mass fit distributions: $m_T$

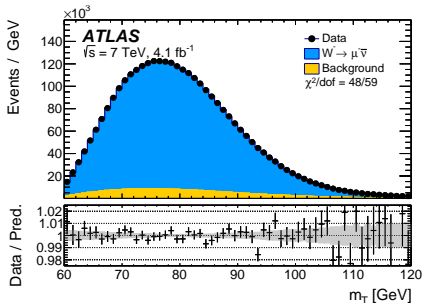
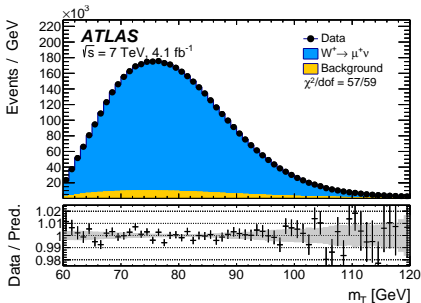
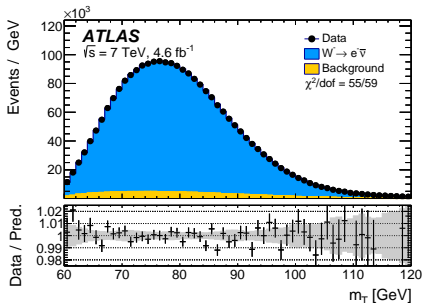
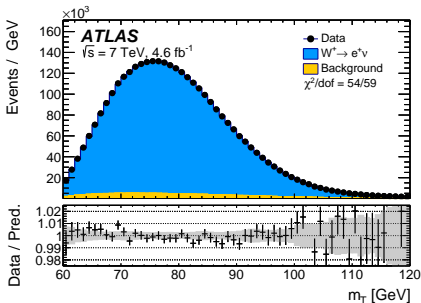

# W-boson mass result per category

- ▶ Analysis binned in  $|\eta|$  and  $W^\pm$ -charge categories and fit performed in both  $p_T^\ell$  and  $m_T$
- ▶  $P(\chi^2)$  distribution over all fit categories: uncertainties well calibrated
- ▶ Combination including correlations:  $\chi^2/\text{n.d.f.} = 29/27$

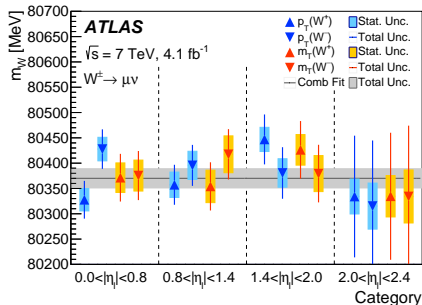
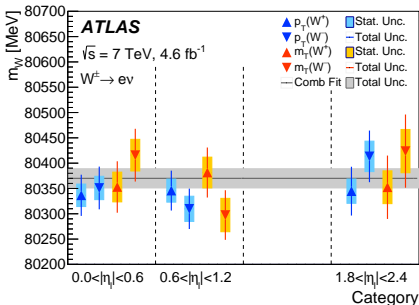
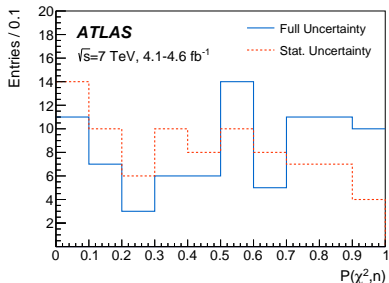

# W-boson mass result per category

Channel $m_T$ -Fit	$m_W$ [MeV]	Stat. Unc.	Muon Unc.	Elec. Unc.	Recoil Unc.	Bkg. Unc.	QCD Unc.	EWK Unc.	PDF Unc.	Total Unc.
$W^+ \rightarrow \mu\nu,  \eta  < 0.8$	80371.3	29.2	12.4	0.0	15.2	8.1	9.9	3.4	28.4	47.1
$W^+ \rightarrow \mu\nu, 0.8 <  \eta  < 1.4$	80354.1	32.1	19.3	0.0	13.0	6.8	9.6	3.4	23.3	47.6
$W^+ \rightarrow \mu\nu, 1.4 <  \eta  < 2.0$	80426.3	30.2	35.1	0.0	14.3	7.2	9.3	3.4	27.2	56.9
$W^+ \rightarrow \mu\nu, 2.0 <  \eta  < 2.4$	80334.6	40.9	112.4	0.0	14.4	9.0	8.4	3.4	32.8	125.5
$W^- \rightarrow \mu\nu,  \eta  < 0.8$	80375.5	30.6	11.6	0.0	13.1	8.5	9.5	3.4	30.6	48.5
$W^- \rightarrow \mu\nu, 0.8 <  \eta  < 1.4$	80417.5	36.4	18.5	0.0	12.2	7.7	9.7	3.4	22.2	49.7
$W^- \rightarrow \mu\nu, 1.4 <  \eta  < 2.0$	80379.4	35.6	33.9	0.0	10.5	8.1	9.7	3.4	23.1	56.9
$W^- \rightarrow \mu\nu, 2.0 <  \eta  < 2.4$	80334.2	52.4	123.7	0.0	11.6	10.2	9.9	3.4	34.1	139.9
$W^+ \rightarrow e\nu,  \eta  < 0.6$	80352.9	29.4	0.0	19.5	13.1	15.3	9.9	3.4	28.5	50.8
$W^+ \rightarrow e\nu, 0.6 <  \eta  < 1.2$	80381.5	30.4	0.0	21.4	15.1	13.2	9.6	3.4	23.5	49.4
$W^+ \rightarrow e\nu, 1.8 <  \eta  < 2.4$	80352.4	32.4	0.0	26.6	16.4	32.8	8.4	3.4	27.3	62.6
$W^- \rightarrow e\nu,  \eta  < 0.6$	80415.8	31.3	0.0	16.4	11.8	15.5	9.5	3.4	31.3	52.1
$W^- \rightarrow e\nu, 0.6 <  \eta  < 1.2$	80297.5	33.0	0.0	18.7	11.2	12.8	9.7	3.4	23.9	49.0
$W^- \rightarrow e\nu, 1.8 <  \eta  < 2.4$	80423.8	42.8	0.0	33.2	12.8	35.1	9.9	3.4	28.1	72.3
<i>p_T</i> -Fit										
$W^+ \rightarrow \mu\nu,  \eta  < 0.8$	80327.7	22.1	12.2	0.0	2.6	5.1	9.0	6.0	24.7	37.3
$W^+ \rightarrow \mu\nu, 0.8 <  \eta  < 1.4$	80357.3	25.1	19.1	0.0	2.5	4.7	8.9	6.0	20.6	39.5
$W^+ \rightarrow \mu\nu, 1.4 <  \eta  < 2.0$	80446.9	23.9	33.1	0.0	2.5	4.9	8.2	6.0	25.2	49.3
$W^+ \rightarrow \mu\nu, 2.0 <  \eta  < 2.4$	80334.1	34.5	110.1	0.0	2.5	6.4	6.7	6.0	31.8	120.2
$W^- \rightarrow \mu\nu,  \eta  < 0.8$	80427.8	23.3	11.6	0.0	2.6	5.8	8.1	6.0	26.4	39.0
$W^- \rightarrow \mu\nu, 0.8 <  \eta  < 1.4$	80395.6	27.9	18.3	0.0	2.5	5.6	8.0	6.0	19.8	40.5
$W^- \rightarrow \mu\nu, 1.4 <  \eta  < 2.0$	80380.6	28.1	35.2	0.0	2.6	5.6	8.0	6.0	20.6	50.9
$W^- \rightarrow \mu\nu, 2.0 <  \eta  < 2.4$	80315.2	45.5	116.1	0.0	2.6	7.6	8.3	6.0	32.7	129.6
$W^+ \rightarrow e\nu,  \eta  < 0.6$	80336.5	22.2	0.0	20.1	2.5	6.4	9.0	5.3	24.5	40.7
$W^+ \rightarrow e\nu, 0.6 <  \eta  < 1.2$	80345.8	22.8	0.0	21.4	2.6	6.7	8.9	5.3	20.5	39.4
$W^+ \rightarrow e\nu, 1.8 <  \eta  < 2.4$	80344.7	24.0	0.0	30.8	2.6	11.9	6.7	5.3	24.1	48.2
$W^- \rightarrow e\nu,  \eta  < 0.6$	80351.0	23.1	0.0	19.8	2.6	7.2	8.1	5.3	26.6	42.2
$W^- \rightarrow e\nu, 0.6 <  \eta  < 1.2$	80309.8	24.9	0.0	19.7	2.7	7.3	8.0	5.3	20.9	39.9
$W^- \rightarrow e\nu, 1.8 <  \eta  < 2.4$	80413.4	30.1	0.0	30.7	2.7	11.5	8.3	5.3	22.7	51.0

$|\eta|$  comb  $e \rightarrow \sim 15$  MeV  
 $\mu \rightarrow \sim 11$  MeV

Strongly  
correlated

Strongly  
correlated

$|\eta|$  comb.  $\rightarrow \sim 14$  MeV  
 $W^+/W^-$  comb  $\rightarrow \sim 9$  MeV

# W-boson mass result

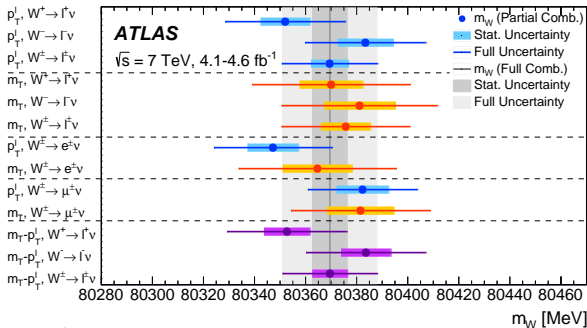

Combination	Weight
Electrons	0.427
Muons	0.573
$m_T$	0.144
$p_T^\ell$	0.856
$W^+$	0.519
$W^-$	0.481

- ▶  $p_T^\ell$  fit dominates – as expected,  $m_T$  mostly validation
- ▶ Electrons contribute significantly

$$\begin{aligned}
 m_{W^+} - m_{W^-} &= -29 \pm 13 \text{ MeV (stat.)} \pm 7 \text{ MeV (exp. syst.)} \pm 24 \text{ MeV (mod. syst.)} \\
 &= -29 \pm 28 \text{ MeV}
 \end{aligned}$$

Channel	$m_{W^+} - m_{W^-}$ [MeV]	Stat. Unc.	Muon Unc.	Elec. Unc.	Recoil Unc.	Bckg. Unc.	QCD Unc.	EW Unc.	PDF Unc.	Total Unc.
$W \rightarrow e\nu$	-29.7	17.5	0.0	4.9	0.9	5.4	0.5	0.0	24.1	30.7
$W \rightarrow \mu\nu$	-28.6	16.3	11.7	0.0	1.1	5.0	0.4	0.0	26.0	33.2
Combined	-29.2	12.8	3.3	4.1	1.0	4.5	0.4	0.0	23.9	28.0



# First ATLAS $W$ -boson mass result

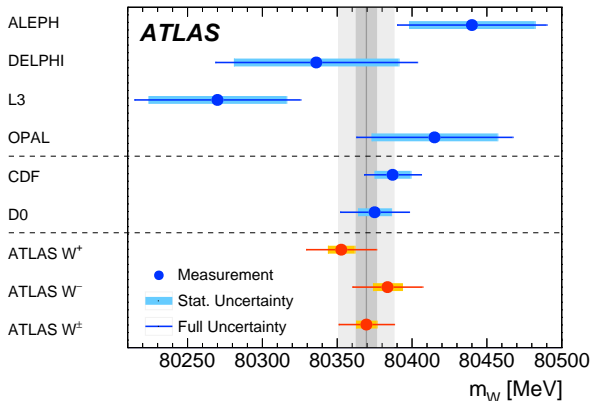

$$m_W = 80370 \pm 7 \text{ MeV}(\text{stat.}) \pm 11 \text{ MeV}(\text{exp. syst.}) \pm 14 \text{ MeV}(\text{mod. syst.})$$

$$= 80370 \pm 19 \text{ MeV}$$

Stat. Unc.	Muon Unc.	Elec. Unc.	Recoil Unc.	Bckg. Unc.	QCD Unc.	EWK Unc.	PDF Unc.	Total Unc.	
6.8	6.6	6.4	2.9	4.5	8.3	5.5	9.2	18.5	[MeV]

# First ATLAS $W$ -boson mass result

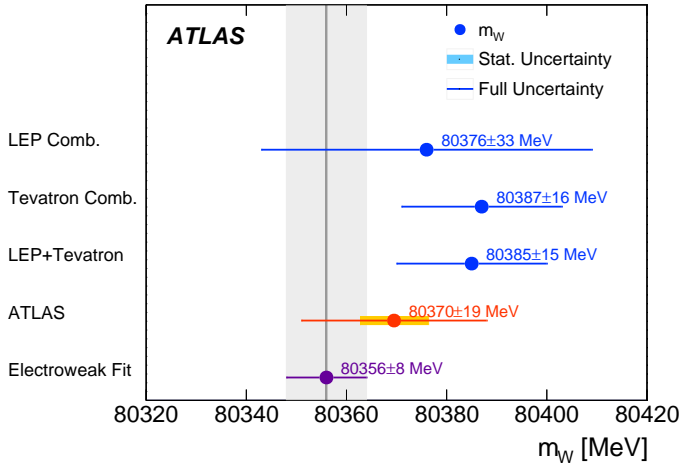

Good agreement with the Standard Model

## Summary & Outlook

Two milestones from the LHC precision frontier:

- ▶ Precision cross-sections at  $< 1\%$  level: strong constraints on PDFs — flavour-symmetry of light-quark sea
- ▶ First measurement of the  $W$ -boson mass at LHC: many thought it would be impossible at this precision; good agreement with SM prediction

Final uncertainties on the interpretation dominated by theory:

- ▶ Possibly not completely unexpected for  $pp$  collisions
- ▶ Some theory limitations can be reduced by performing and incorporating additional measurements (8 TeV and 13 TeV)
- ▶ Help from the theorists to improve modelling

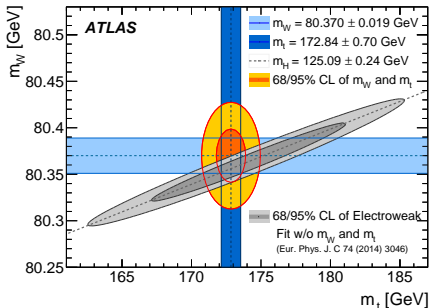
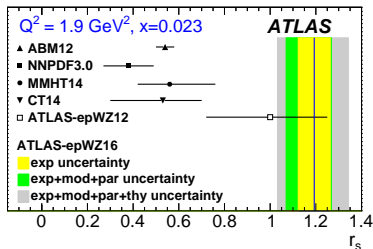



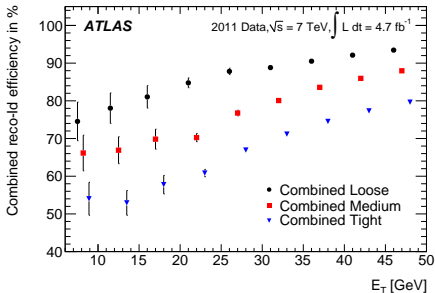
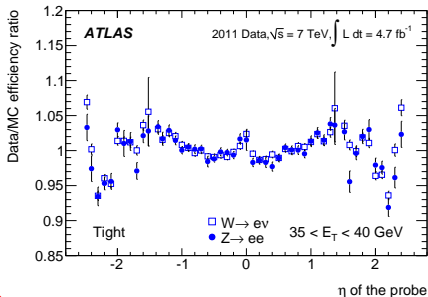
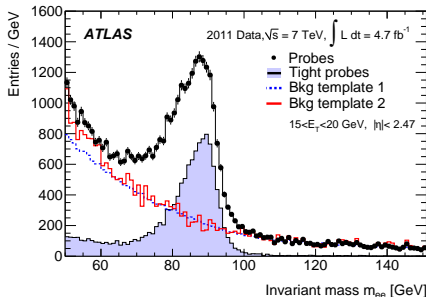
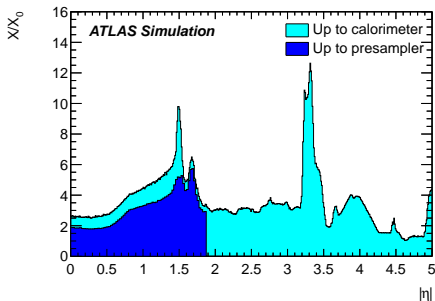

- Scale and resolution calibration using projections parallel and transverse to Z direction

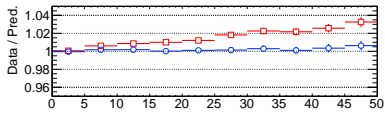
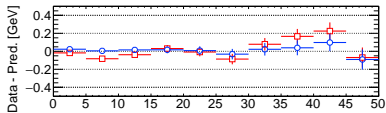
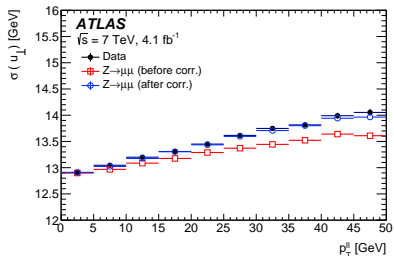
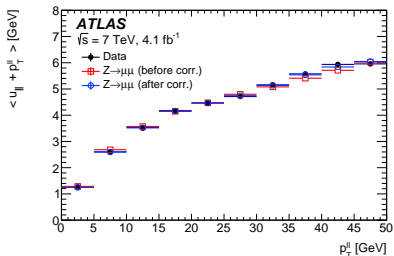

# W-boson mass fit distributions: $p_T^{\text{miss}}$

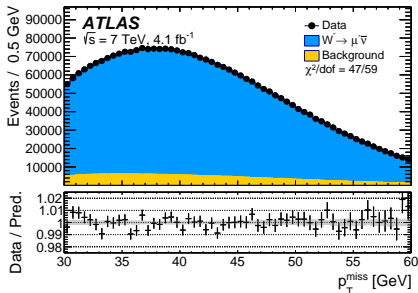
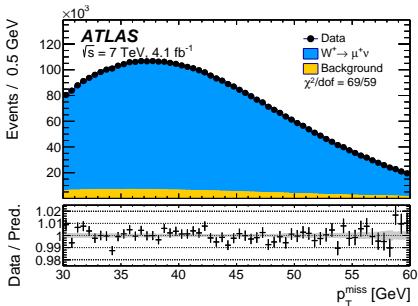
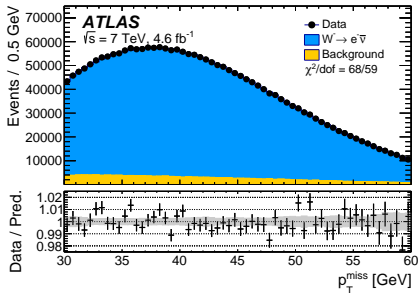
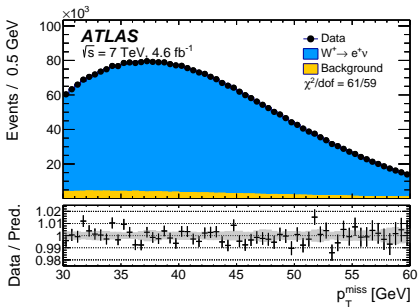

# W-boson mass: $\phi$ dependence

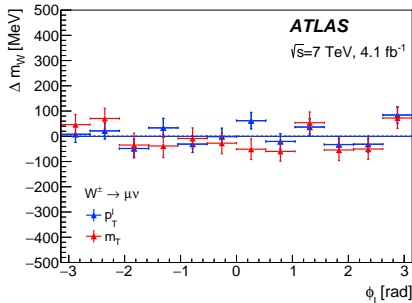
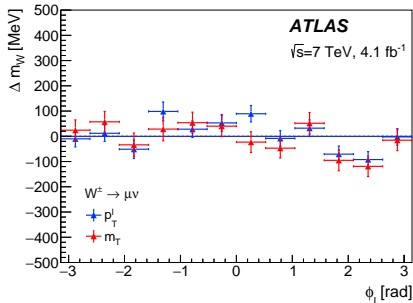
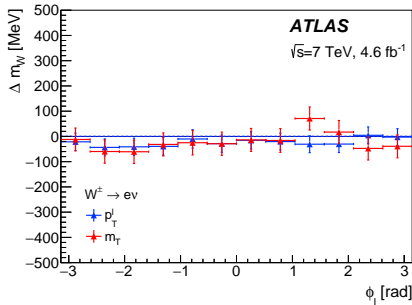
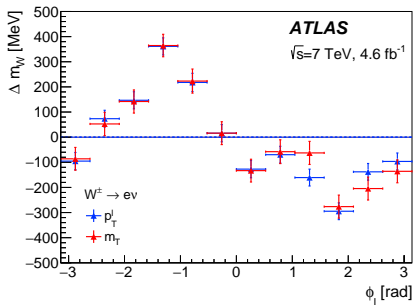



# W-boson mass: boson $p_T$ $W$ vs. $Z$

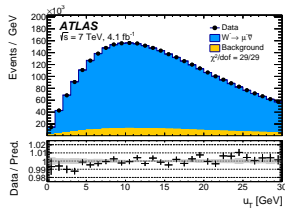
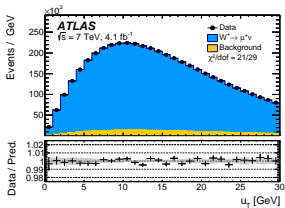
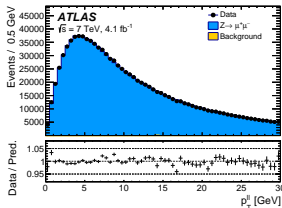
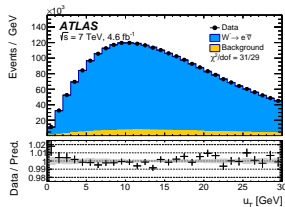
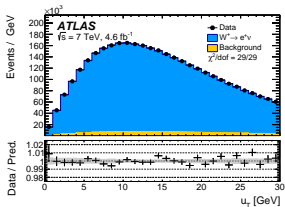
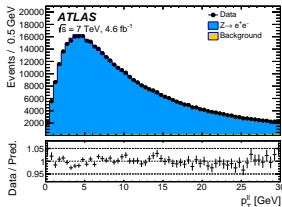

Decay channel Kinematic distribution	$W \rightarrow e\nu$		$W \rightarrow \mu\nu$		Combined	
	$p_T^\ell$	$m_T$	$p_T^\ell$	$m_T$	$p_T^\ell$	$m_T$
$\Delta m_W$ [MeV]						
$\langle \mu \rangle$ in [2.5, 6.5]	$8 \pm 14$	$14 \pm 18$	$-21 \pm 12$	$0 \pm 16$	$-9 \pm 9$	$6 \pm 12$
$\langle \mu \rangle$ in [6.5, 9.5]	$-6 \pm 16$	$6 \pm 23$	$12 \pm 15$	$-8 \pm 22$	$4 \pm 11$	$-1 \pm 16$
$\langle \mu \rangle$ in [9.5, 16]	$-1 \pm 16$	$3 \pm 27$	$25 \pm 16$	$35 \pm 26$	$12 \pm 11$	$20 \pm 19$
$u_T$ in [0, 15]GeV	$0 \pm 11$	$-8 \pm 13$	$5 \pm 10$	$8 \pm 12$	$3 \pm 7$	$-1 \pm 9$
$u_T$ in [15, 30]GeV	$10 \pm 15$	$0 \pm 24$	$-4 \pm 14$	$-18 \pm 22$	$2 \pm 10$	$-10 \pm 16$
$u_{\parallel}^\ell < 0 \text{ GeV}$	$8 \pm 15$	$20 \pm 17$	$3 \pm 13$	$-1 \pm 16$	$5 \pm 10$	$9 \pm 12$
$u_{\parallel}^\ell > 0 \text{ GeV}$	$-9 \pm 10$	$1 \pm 14$	$-12 \pm 10$	$10 \pm 13$	$-11 \pm 7$	$6 \pm 10$
No $p_T^{\text{miss}}$ -cut	$14 \pm 9$	$-1 \pm 13$	$10 \pm 8$	$-6 \pm 12$	$12 \pm 6$	$-4 \pm 9$

# W mass: category summary

Combined categories	Value [MeV]	Stat. Unc.	Muon Unc.	Elec. Unc.	Recoil Unc.	Bckg. Unc.	QCD Unc.	EW Unc.	PDF Unc.	Total Unc.	$\chi^2/\text{dof}$ of Comb.
$m_T, W^+, e-\mu$	80370.0	12.3	8.3	6.7	14.5	9.7	9.4	3.4	16.9	30.9	2/6
$m_T, W^-, e-\mu$	80381.1	13.9	8.8	6.6	11.8	10.2	9.7	3.4	16.2	30.5	7/6
$m_T, W^\pm, e-\mu$	80375.7	9.6	7.8	5.5	13.0	8.3	9.6	3.4	10.2	25.1	11/13
$p_T^\ell, W^+, e-\mu$	80352.0	9.6	6.5	8.4	2.5	5.2	8.3	5.7	14.5	23.5	5/6
$p_T^\ell, W^-, e-\mu$	80383.4	10.8	7.0	8.1	2.5	6.1	8.1	5.7	13.5	23.6	10/6
$p_T^\ell, W^\pm, e-\mu$	80369.4	7.2	6.3	6.7	2.5	4.6	8.3	5.7	9.0	18.7	19/13
$p_T^\ell, W^\pm, e$	80347.2	9.9	0.0	14.8	2.6	5.7	8.2	5.3	8.9	23.1	4/5
$m_T, W^\pm, e$	80364.6	13.5	0.0	14.4	13.2	12.8	9.5	3.4	10.2	30.8	8/5
$m_T-p_T^\ell, W^+, e$	80345.4	11.7	0.0	16.0	3.8	7.4	8.3	5.0	13.7	27.4	1/5
$m_T-p_T^\ell, W^-, e$	80359.4	12.9	0.0	15.1	3.9	8.5	8.4	4.9	13.4	27.6	8/5
$m_T-p_T^\ell, W^\pm, e$	80349.8	9.0	0.0	14.7	3.3	6.1	8.3	5.1	9.0	22.9	12/11
$p_T^\ell, W^\pm, \mu$	80382.3	10.1	10.7	0.0	2.5	3.9	8.4	6.0	10.7	21.4	7/7
$m_T, W^\pm, \mu$	80381.5	13.0	11.6	0.0	13.0	6.0	9.6	3.4	11.2	27.2	3/7
$m_T-p_T^\ell, W^+, \mu$	80364.1	11.4	12.4	0.0	4.0	4.7	8.8	5.4	17.6	27.2	5/7
$m_T-p_T^\ell, W^-, \mu$	80398.6	12.0	13.0	0.0	4.1	5.7	8.4	5.3	16.8	27.4	3/7
$m_T-p_T^\ell, W^\pm, \mu$	80382.0	8.6	10.7	0.0	3.7	4.3	8.6	5.4	10.9	21.0	10/15
$m_T-p_T^\ell, W^+, e-\mu$	80352.7	8.9	6.6	8.2	3.1	5.5	8.4	5.4	14.6	23.4	7/13
$m_T-p_T^\ell, W^-, e-\mu$	80383.6	9.7	7.2	7.8	3.3	6.6	8.3	5.3	13.6	23.4	15/13
$m_T-p_T^\ell, W^\pm, e-\mu$	80369.5	6.8	6.6	6.4	2.9	4.5	8.3	5.5	9.2	18.5	29/27

W-boson charge Kinematic distribution	$W^+$		$W^-$		Combined	
	$p_T^\ell$	$m_T$	$p_T^\ell$	$m_T$	$p_T^\ell$	$m_T$
$\delta m_W$ [MeV]						
Fixed-order PDF uncertainty	13.1	14.9	12.0	14.2	8.0	8.7
AZ tune	3.0	3.4	3.0	3.4	3.0	3.4
Charm-quark mass	1.2	1.5	1.2	1.5	1.2	1.5
Parton shower $\mu_F$ with heavy-flavour decorrelation	5.0	6.9	5.0	6.9	5.0	6.9
Parton shower PDF uncertainty	3.6	4.0	2.6	2.4	1.0	1.6
Angular coefficients	5.8	5.3	5.8	5.3	5.8	5.3
Total	15.9	18.1	14.8	17.2	11.6	12.9

# W mass: electron & muon uncertainties

$ \eta_\ell $ range	[0.0, 0.6]		[0.6, 1.2]		[1.82, 2.4]		Combined	
	$p_T^\ell$	$m_T$	$p_T^\ell$	$m_T$	$p_T^\ell$	$m_T$	$p_T^\ell$	$m_T$
Kinematic distribution								
$\delta m_W$ [MeV]								
Energy scale	10.4	10.3	10.8	10.1	16.1	17.1	8.1	8.0
Energy resolution	5.0	6.0	7.3	6.7	10.4	15.5	3.5	5.5
Energy linearity	2.2	4.2	5.8	8.9	8.6	10.6	3.4	5.5
Energy tails	2.3	3.3	2.3	3.3	2.3	3.3	2.3	3.3
Reconstruction efficiency	10.5	8.8	9.9	7.8	14.5	11.0	7.2	6.0
Identification efficiency	10.4	7.7	11.7	8.8	16.7	12.1	7.3	5.6
Trigger and isolation efficiencies	0.2	0.5	0.3	0.5	2.0	2.2	0.8	0.9
Charge mismeasurement	0.2	0.2	0.2	0.2	1.5	1.5	0.1	0.1
Total	19.0	17.5	21.1	19.4	30.7	30.5	14.2	14.3

$ \eta_\ell $ range	[0.0, 0.8]		[0.8, 1.4]		[1.4, 2.0]		[2.0, 2.4]		Combined	
	$p_T^\ell$	$m_T$	$p_T^\ell$	$m_T$	$p_T^\ell$	$m_T$	$p_T^\ell$	$m_T$	$p_T^\ell$	$m_T$
Kinematic distribution										
$\delta m_W$ [MeV]										
Momentum scale	8.9	9.3	14.2	15.6	27.4	29.2	111.0	115.4	8.4	8.8
Momentum resolution	1.8	2.0	1.9	1.7	1.5	2.2	3.4	3.8	1.0	1.2
Sagitta bias	0.7	0.8	1.7	1.7	3.1	3.1	4.5	4.3	0.6	0.6
Reconstruction and isolation efficiencies	4.0	3.6	5.1	3.7	4.7	3.5	6.4	5.5	2.7	2.2
Trigger efficiency	5.6	5.0	7.1	5.0	11.8	9.1	12.1	9.9	4.1	3.2
Total	11.4	11.4	16.9	17.0	30.4	31.0	112.0	116.1	9.8	9.7

## W mass: recoil & background uncertainties

W-boson charge Kinematic distribution	$W^+$		$W^-$		Combined	
	$p_T^\ell$	$m_T$	$p_T^\ell$	$m_T$	$p_T^\ell$	$m_T$
$\delta m_W$ [MeV]						
$\langle \mu \rangle$ scale factor	0.2	1.0	0.2	1.0	0.2	1.0
$\Sigma \bar{E}_T$ correction	0.9	12.2	1.1	10.2	1.0	11.2
Residual corrections (statistics)	2.0	2.7	2.0	2.7	2.0	2.7
Residual corrections (interpolation)	1.4	3.1	1.4	3.1	1.4	3.1
Residual corrections ( $Z \rightarrow W$ extrapolation)	0.2	5.8	0.2	4.3	0.2	5.1
Total	2.6	14.2	2.7	11.8	2.6	13.0
W-boson charge Kinematic distribution	$W^+$		$W^-$		Combined	
	$p_T^\ell$	$m_T$	$p_T^\ell$	$m_T$	$p_T^\ell$	$m_T$
$\delta m_W$ [MeV]						
$\langle \mu \rangle$ scale factor	0.2	1.0	0.2	1.0	0.2	1.0
$\Sigma \bar{E}_T$ correction	0.9	12.2	1.1	10.2	1.0	11.2
Residual corrections (statistics)	2.0	2.7	2.0	2.7	2.0	2.7
Residual corrections (interpolation)	1.4	3.1	1.4	3.1	1.4	3.1
Residual corrections ( $Z \rightarrow W$ extrapolation)	0.2	5.8	0.2	4.3	0.2	5.1
Total	2.6	14.2	2.7	11.8	2.6	13.0

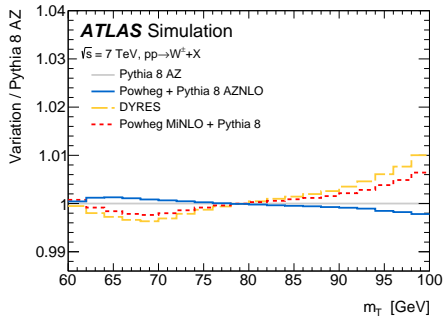
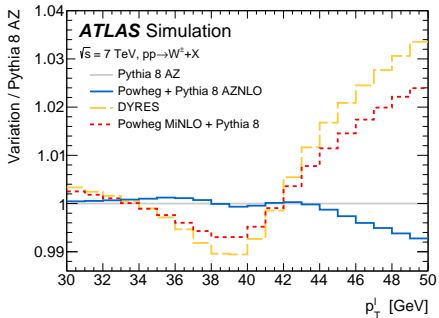

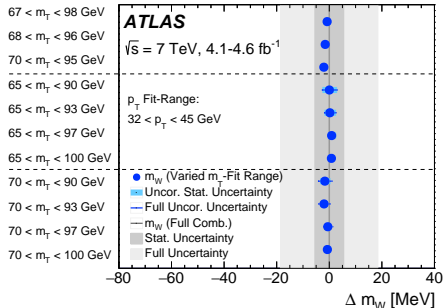
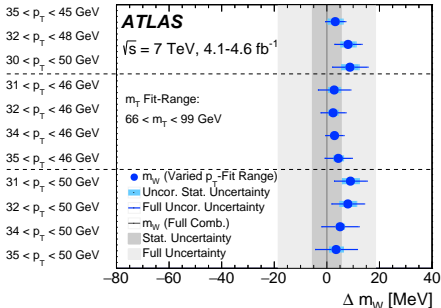



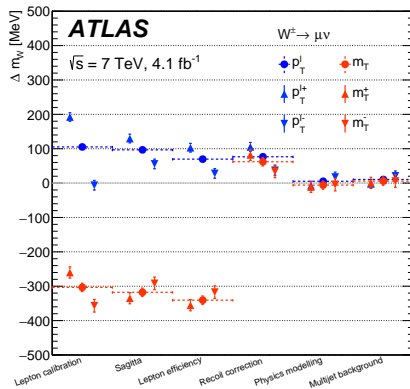
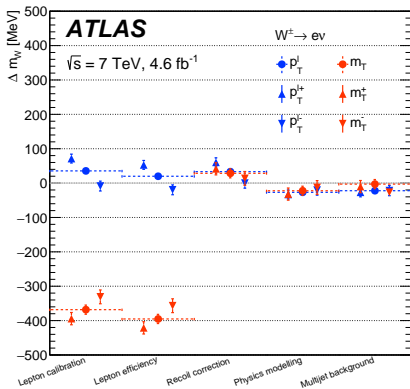

Stat. Unc.	Muon Unc.	Elec. Unc.	Recoil Unc.	Bckg. Unc.	QCD Unc.	EWK Unc.	PDF Unc.	Total Unc.	
6.8	6.6	6.4	2.9	4.5	8.3	5.5	9.2	18.5	[MeV]

Source	Uncertainty
Lepton energy scale and resolution	7
Recoil energy scale and resolution	6
Lepton tower removal	2
Backgrounds	3
PDFs	10
$p_T(W)$ model	5
Photon radiation	4
Statistical	12
Total	19

- ▶ Vector bosons are produced with non-zero transverse momentum: interesting interplay of effects from resummation and hard (jet) emissions
- ▶ High precision 2011 and 2012 results with  $\lesssim 0.5\%$  precision after  $ee + \mu\mu$  combination over a wide range!
- ▶ 2012 analysis extent to off-peak measurements: data/theory agreement not good at  $\mathcal{O}(\alpha_s^2)$ , improved with very recent  $\mathcal{O}(\alpha_s^3)$  calculation – remainder PDFs?
- ▶ Important for  $W$  mass measurement, Higgs predictions, BSM searches...

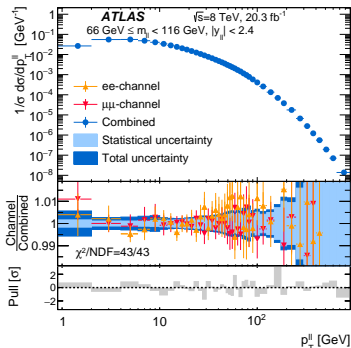
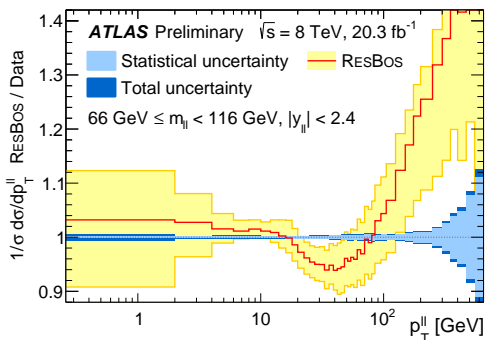

- ▶ Vector bosons are produced with non-zero transverse momentum: interesting interplay of effects from resummation and hard (jet) emissions
- ▶ High precision 2011 and 2012 results with  $\lesssim 0.5\%$  precision after  $ee + \mu\mu$  combination over a wide range!
- ▶ 2012 analysis extent to off-peak measurements: data/theory agreement not good at  $\mathcal{O}(\alpha_s^2)$ , improved with very recent  $\mathcal{O}(\alpha_s^3)$  calculation – remainder PDFs?
- ▶ Important for  $W$  mass measurement, Higgs predictions, BSM searches...

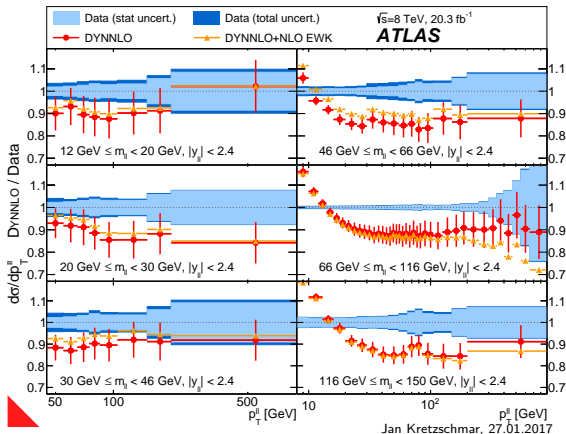

- ▶ Vector bosons are produced with non-zero transverse momentum: interesting interplay of effects from resummation and hard (jet) emissions
- ▶ High precision 2011 and 2012 results with  $\lesssim 0.5\%$  precision after  $ee + \mu\mu$  combination over a wide range!
- ▶ 2012 analysis extent to off-peak measurements: data/theory agreement not good at  $\mathcal{O}(\alpha_s^2)$ , improved with very recent  $\mathcal{O}(\alpha_s^3)$  calculation – remainder PDFs?
- ▶ Important for  $W$  mass measurement, Higgs predictions, BSM searches...

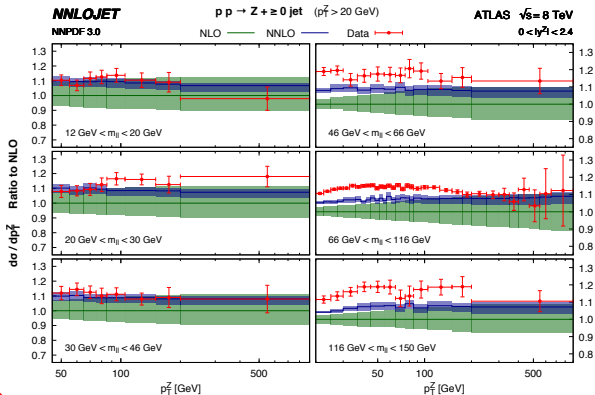

- PDF  $Q^2$  evolution: *DGLAP equations* [Altarelli and Parisi, 1977]

$$\frac{dq^i(x,t)}{dt} = \frac{\alpha(t)}{2\pi} \int_x^1 \frac{dy}{y} \left[ \sum_j^{2f} q^j(y,t) P_{q_i q_j} \left( \frac{x}{y} \right) + G(y,t) P_{q_i G} \left( \frac{x}{y} \right) \right] \quad (22)$$

$$\frac{dG(x,t)}{dt} = \frac{\alpha(t)}{2\pi} \int_x^1 \frac{dy}{y} \left[ \sum_j^{2f} q^j(y,t) P_{G q_j} \left( \frac{x}{y} \right) + G(y,t) P_{G G} \left( \frac{x}{y} \right) \right] \quad (23)$$

$$(t = \ln Q^2/Q_0^2)$$

- Full LHC  $W, Z$  production  $x$  range only covered by HERA NC data

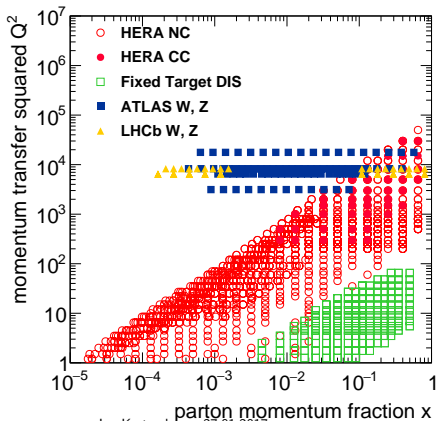

## CMS Peak Luminosity Per Day, pp

Data included from 2010-03-30 11:22 to 2016-10-27 14:12 UTC

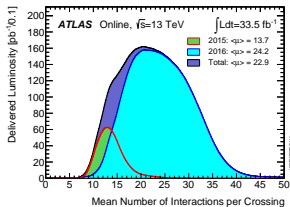
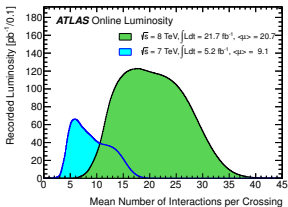
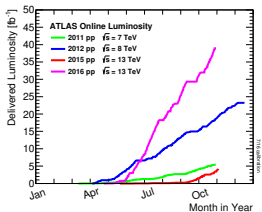
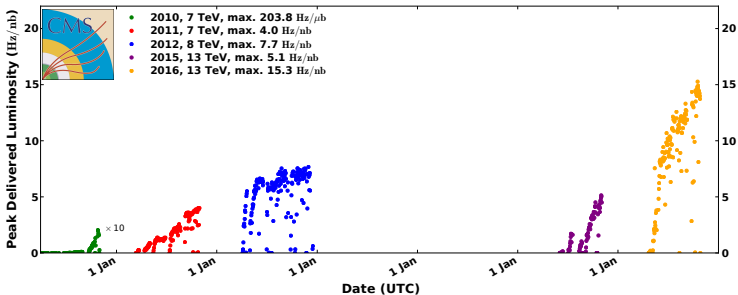

- ▶ Main experimental issue for  $W$  and  $Z$  is quantitative understanding of lepton performance: selection efficiencies, energy/momentum scales
- ▶ Thanks to the large  $Z \rightarrow \ell\ell$  samples this is mostly an exercise in time and dedication
- ▶ Muon efficiencies and calibration both known at the  $< 0.1\%$  level (non-uniformities in muon spectrometer and ID+MS alignment at  $\mu\text{m}$  level)

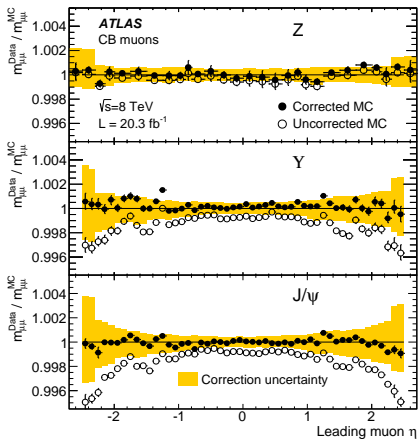
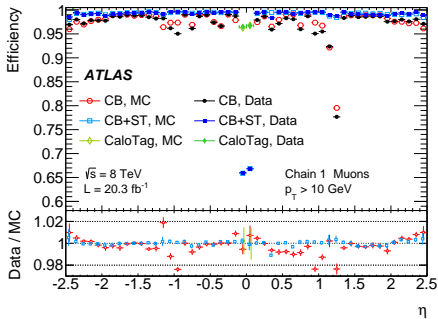



- ▶  $W^+ \rightarrow \ell^+ \nu$  and  $W^- \rightarrow \ell^- \nu$  measured integrated and as function of charged lepton rapidity  $|\eta_\ell|$ : typical precision 0.6 – 1.0%
- ▶  $Z/\gamma^* \rightarrow \ell\ell$  measured integrated and as function of di-lepton rapidity  $|y_{\ell\ell}|$  and di-lepton mass  $m_{\ell\ell}$ : typical precision 0.4%, forward Z 2.3%

## Electron channels

	$\delta\sigma_{W^+}$	$\delta\sigma_{W^-}$	$\delta\sigma_Z$	$\delta\sigma_{\text{forward } Z}$
	[%]	[%]	[%]	[%]
Trigger efficiency	0.03	0.03	0.05	0.05
Reconstruction efficiency	0.12	0.12	0.20	0.13
Identification efficiency	0.09	0.09	0.16	0.12
Forward identification efficiency	–	–	–	1.51
Isolation efficiency	0.03	0.03	–	0.04
Charge misidentification	0.04	0.06	–	–
Electron $p_T$ resolution	0.02	0.03	0.01	0.01
Electron $p_T$ scale	0.22	0.18	0.08	0.12
Forward electron $p_T$ scale + resolution	–	–	–	0.18
$E_T^{\text{miss}}$ soft term scale	0.14	0.13	–	–
$E_T^{\text{miss}}$ soft term resolution	0.06	0.04	–	–
Jet energy scale	0.04	0.02	–	–
Jet energy resolution	0.11	0.15	–	–
Signal modelling (matrix-element generator)	0.57	0.64	0.03	1.12
Signal modelling (parton shower and hadronization)	0.24	0.25	0.18	1.25
PDF	0.10	0.12	0.09	0.06
Boson $p_T$	0.22	0.19	0.01	0.04
Multijet background	0.55	0.72	0.03	0.05
Electroweak+top background	0.17	0.19	0.02	0.14
Background statistical uncertainty	0.02	0.03	<0.01	0.04
Unfolding statistical uncertainty	0.03	0.04	0.04	0.13
Data statistical uncertainty	0.04	0.05	0.10	0.18
Total experimental uncertainty	0.94	1.08	0.35	2.29
Luminosity			1.8	

## Muon channels

	$\delta\sigma_{W^+}$	$\delta\sigma_{W^-}$	$\delta\sigma_Z$
	[%]	[%]	[%]
Trigger efficiency	0.08	0.07	0.05
Reconstruction efficiency	0.19	0.17	0.30
Isolation efficiency	0.10	0.09	0.15
Muon $p_T$ resolution	0.01	0.01	<0.01
Muon $p_T$ scale	0.18	0.17	0.03
$E_T^{\text{miss}}$ soft term scale	0.19	0.19	–
$E_T^{\text{miss}}$ soft term resolution	0.10	0.09	–
Jet energy scale	0.09	0.12	–
Jet energy resolution	0.11	0.16	–
Signal modelling (matrix-element generator)	0.12	0.06	0.04
Signal modelling (parton shower and hadronization)	0.14	0.17	0.22
PDF	0.09	0.12	0.07
Boson $p_T$	0.18	0.14	0.04
Multijet background	0.33	0.27	0.07
Electroweak+top background	0.19	0.24	0.02
Background statistical uncertainty	0.03	0.04	0.01
Unfolding statistical uncertainty	0.03	0.03	0.02
Data statistical uncertainty	0.04	0.04	0.08
Total experimental uncertainty	0.61	0.59	0.43
Luminosity		1.8	

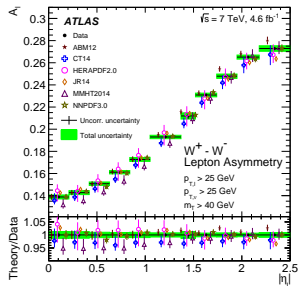
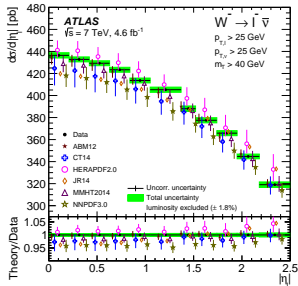
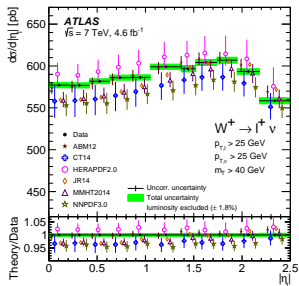

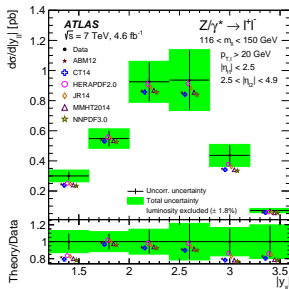
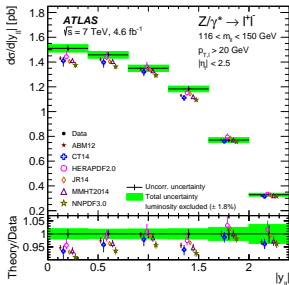
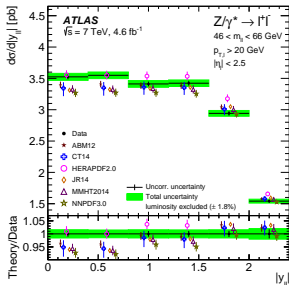
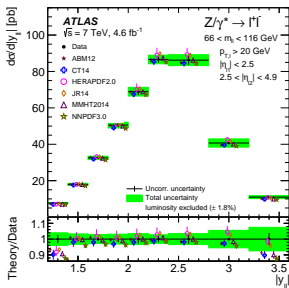
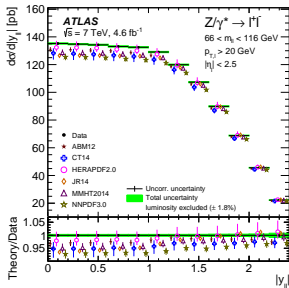

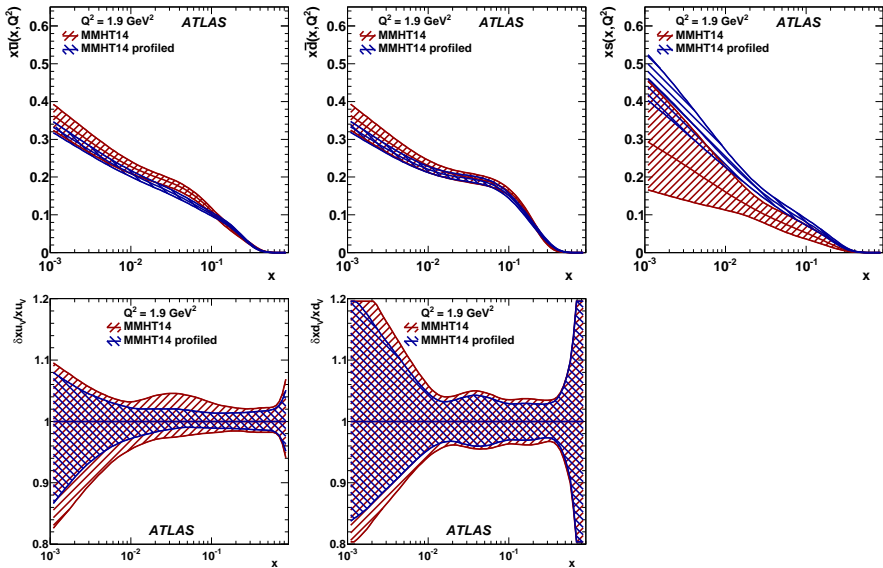

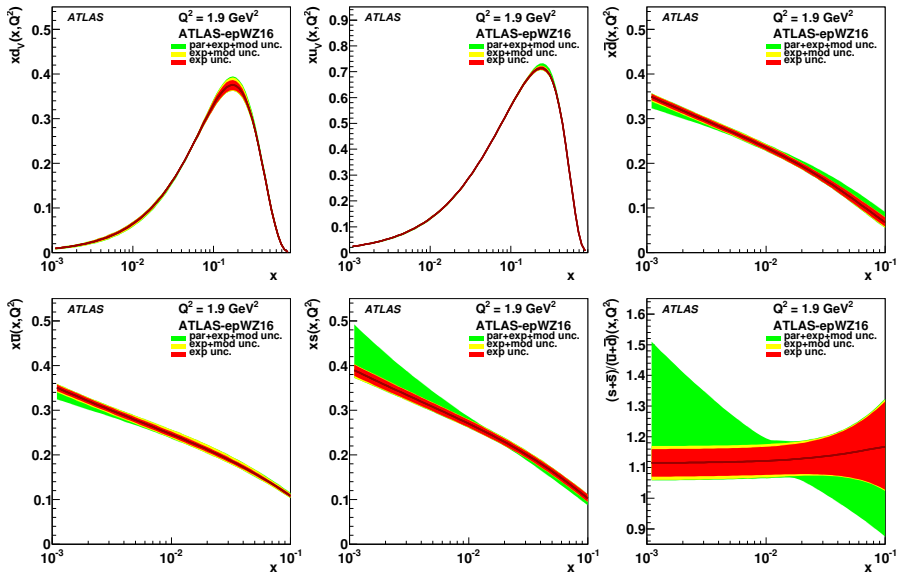

- ▶ Data is also sensitive to the magnitude of the CKM matrix element  $|V_{cs}|$ , which is not well measured experimentally (although well determined when imposing CKM unitarity)
- ▶ Related to strange density, as dependence is through  $cs \rightarrow W$  contribution (20 – 30% of  $W$  cross section)
- ▶ Determination competitive with existing values, much improved compared to earlier NNPDF1.2 fit

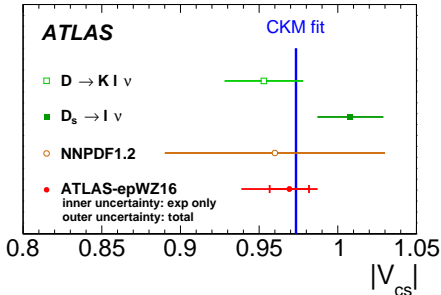

	$ V_{cs} $
Central value	0.969
Experimental data	$\pm 0.013$
Model ( $m_b, Q_{\min}^2, Q_0^2$ & $m_c$ )	+0.006 -0.003
Parameterization	+0.003 -0.027
$\alpha_s$	$\pm 0.000$
Beam energy $E_p$	$\pm 0.001$
EW corrections	$\pm 0.004$
QCD scales	+0.000 -0.003
FEWZ 3.1b2	+0.011
Total uncertainty	+0.018 -0.031

# Strange

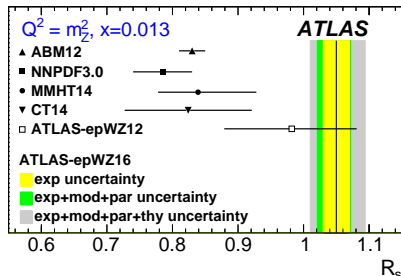
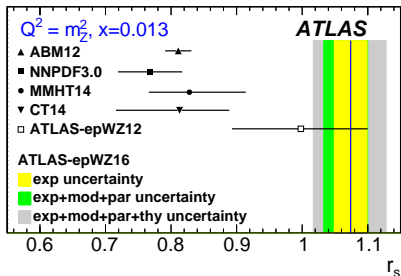
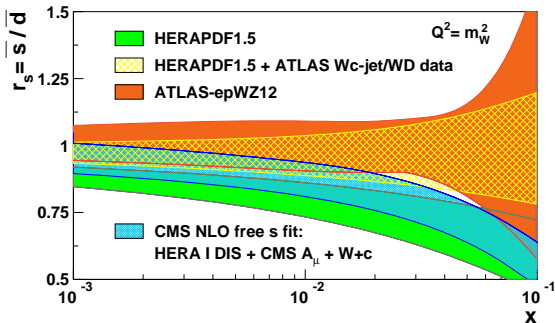

PDF parameterised at starting scale  $Q_0^2$  with 15 free parameters

$$xu_v(x) = A_{u_v} x^{B_{u_v}} (1-x)^{C_{u_v}} (1 + E_{u_v} x^2),$$

$$xd_v(x) = A_{d_v} x^{B_{d_v}} (1-x)^{C_{d_v}},$$

$$x\bar{u}(x) = A_{\bar{u}} x^{B_{\bar{u}}} (1-x)^{C_{\bar{u}}},$$

$$x\bar{d}(x) = A_{\bar{d}} x^{B_{\bar{d}}} (1-x)^{C_{\bar{d}}},$$

$$xg(x) = A_g x^{B_g} (1-x)^{C_g} - A'_g x^{B'_g} (1-x)^{C'_g},$$

$$x\bar{s}(x) = A_{\bar{s}} x^{B_{\bar{s}}} (1-x)^{C_{\bar{s}}},$$



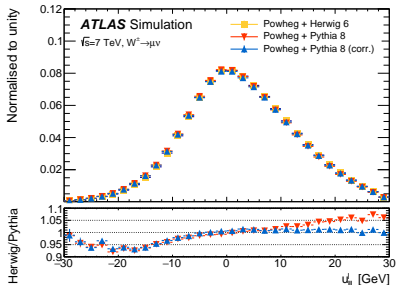
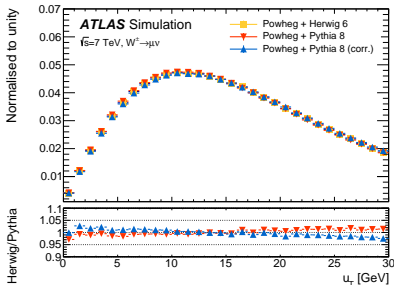
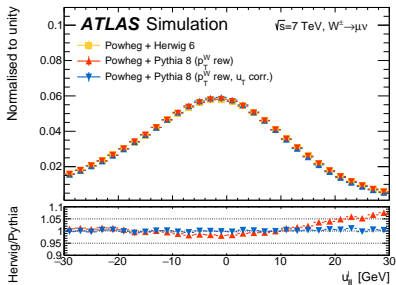
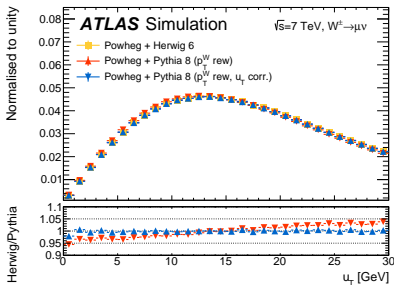

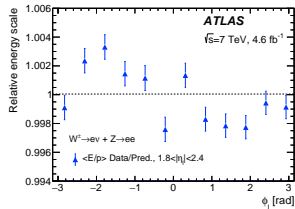
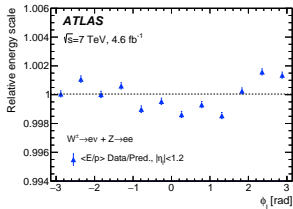
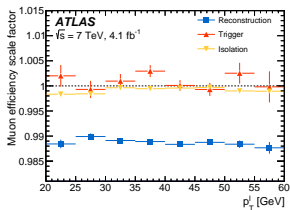

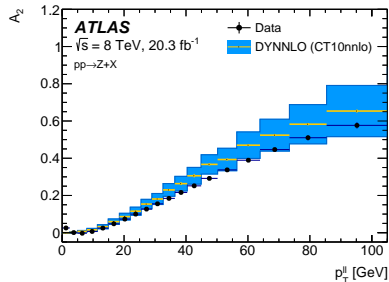
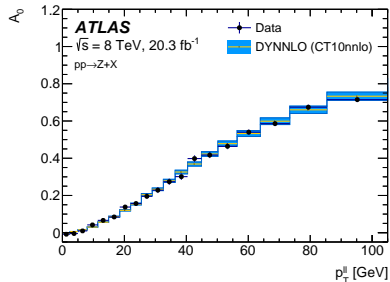
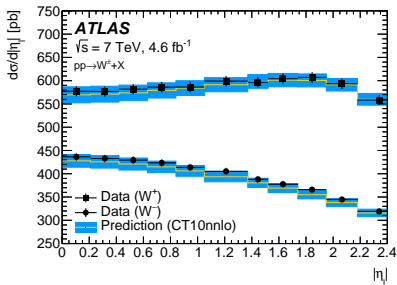
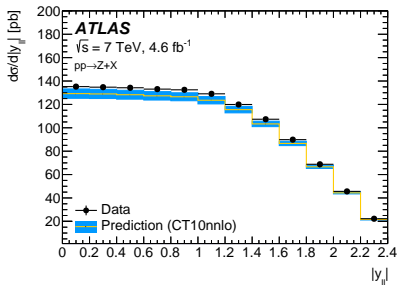

# W mass: weights

Observable	Channel	$\eta$ range	Weight
$m_T$	$W^+ \rightarrow \mu\nu$	$ \eta  < 0.8$	0.018
		$0.8 <  \eta  < 1.4$	0.022
		$1.4 <  \eta  < 2.0$	0.003
		$2.0 <  \eta  < 2.4$	0.006
	$W^- \rightarrow \mu\nu$	$ \eta  < 0.8$	0.020
		$0.8 <  \eta  < 1.4$	0.018
		$1.4 <  \eta  < 2.0$	0.022
		$2.0 <  \eta  < 2.4$	0.001
	$W^+ \rightarrow e\nu$	$ \eta  < 0.6$	0.013
		$0.6 <  \eta  < 1.2$	0.001
		$1.8 <  \eta  < 2.4$	0.010
	$W^- \rightarrow e\nu$	$ \eta  < 0.6$	0.008
		$0.6 <  \eta  < 1.2$	0.000
		$1.8 <  \eta  < 2.4$	0.002
$p_T^\ell$	$W^+ \rightarrow \mu\nu$	$ \eta  < 0.8$	0.101
		$0.8 <  \eta  < 1.4$	0.076
		$1.4 <  \eta  < 2.0$	0.050
		$2.0 <  \eta  < 2.4$	0.011
	$W^- \rightarrow \mu\nu$	$ \eta  < 0.8$	0.097
		$0.8 <  \eta  < 1.4$	0.071
		$1.4 <  \eta  < 2.0$	0.047
		$2.0 <  \eta  < 2.4$	0.010
	$W^+ \rightarrow e\nu$	$ \eta  < 0.6$	0.056
		$0.6 <  \eta  < 1.2$	0.071
		$1.8 <  \eta  < 2.4$	0.081
	$W^- \rightarrow e\nu$	$ \eta  < 0.6$	0.062
		$0.6 <  \eta  < 1.2$	0.056
		$1.8 <  \eta  < 2.4$	0.067

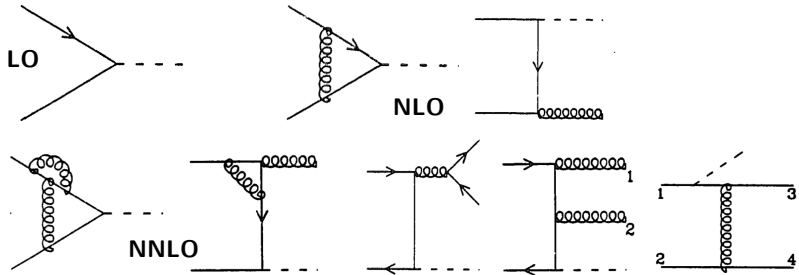

# W, Z Combination

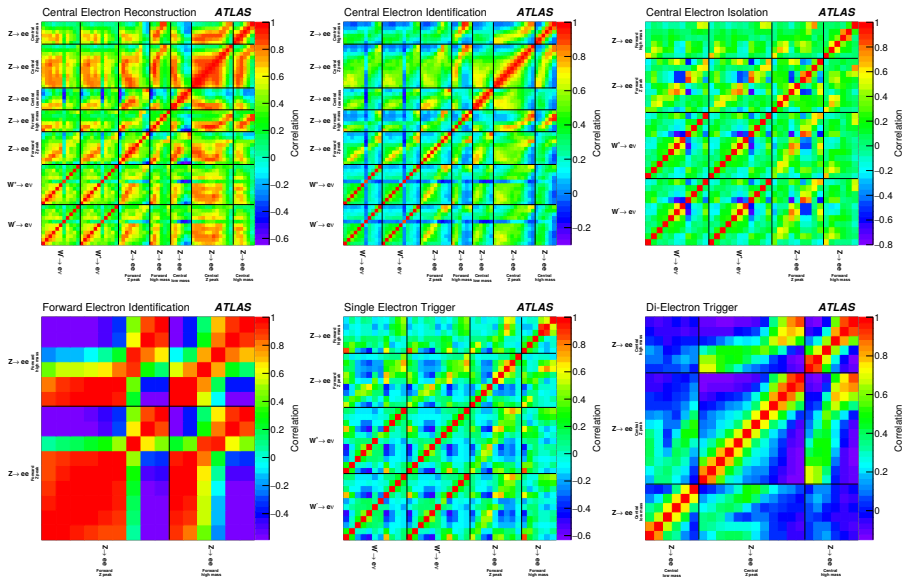

# W, Z Combination

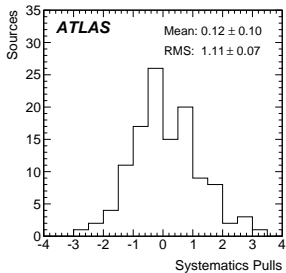
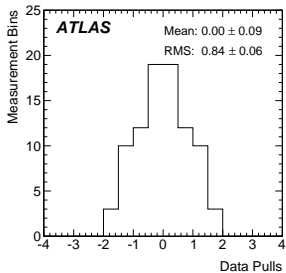
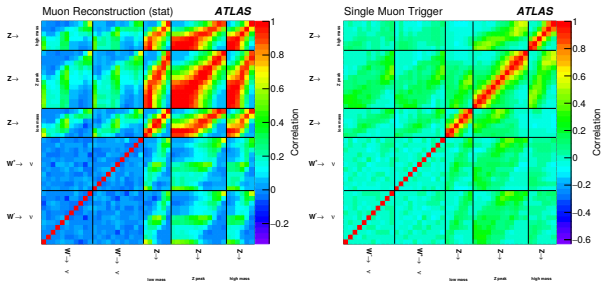

# W, Z Combination

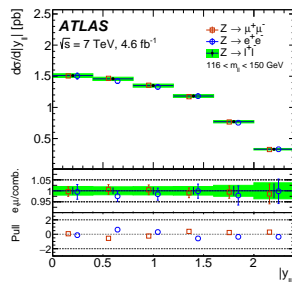
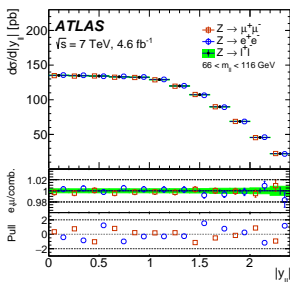
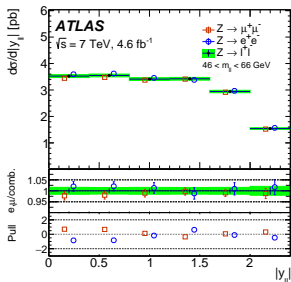
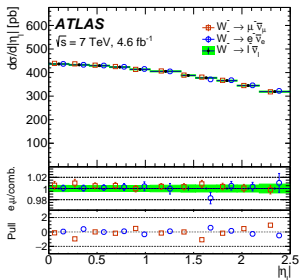
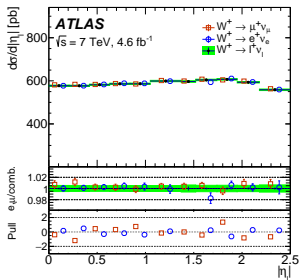



# The five-dimensional DY cross sections

- ▶ Description of production and decay of single  $W^\pm \rightarrow l\nu$  and  $Z/\gamma^* \rightarrow \ell\ell$  depends on five kinematic variables:
  - ▶ Boson 4-vector: di-lepton mass  $m_{\ell\ell}$ , transverse momentum  $p_{T,\ell\ell}$  and rapidity  $y_{\ell\ell}$
  - ▶ Spin-1 of  $W/Z/\gamma^*$  bosons and EWK coupling effects the two decay leptons have non-trivial angular correlations ( $\theta_{CS}$  and  $\phi_{CS}$ )
- ▶ Can be factorised as

$$\frac{d\sigma}{dm_{\ell\ell} dp_{T,\ell\ell} dy_{\ell\ell}} \left[ 1 + \cos^2 \theta_{CS} + \sum_{i=0}^7 A_i(m, p_T, y) f_i(\theta_{CS}, \phi_{CS}) \right]$$

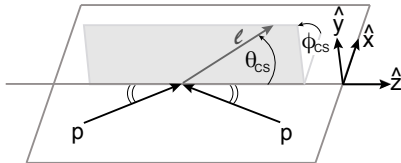
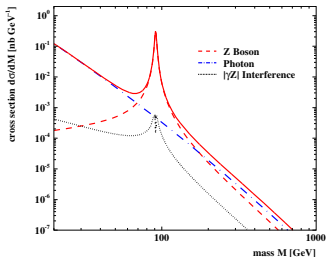

# A $W \rightarrow \mu\nu$ candidate

Run: 152845, Event: 3338173  
Date: 2010-04-12 16:56:44 CEST



# ATLAS EXPERIMENT

$p_T(\mu^-) = 40 \text{ GeV}$   
 $\eta(\mu^-) = 2.0$   
 $E_T^{\text{miss}} = 41 \text{ GeV}$   
 $M_T = 83 \text{ GeV}$

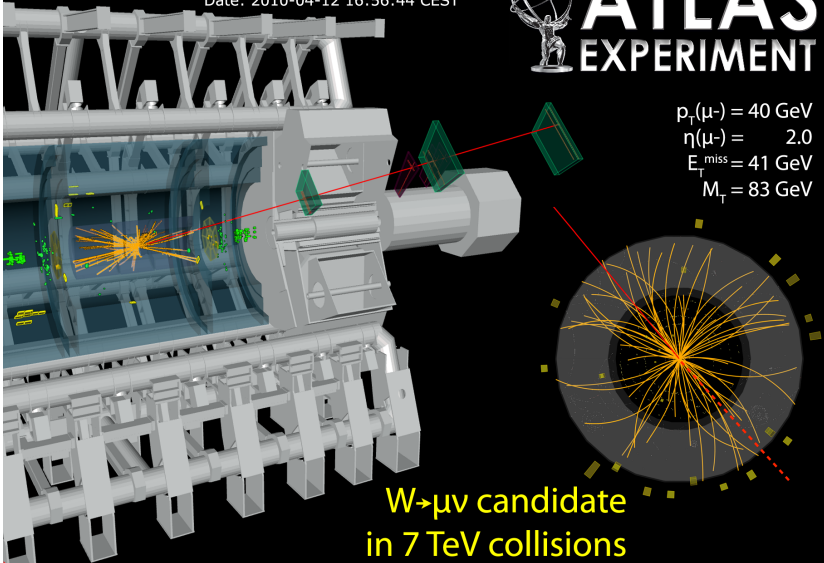

# A $Z \rightarrow ee$ candidate



Run Number: 154817, Event Number: 968871  
Date: 2010-05-09 09:41:40 CEST

$M_{ee} = 89 \text{ GeV}$

Z-ee candidate in 7 TeV collisions

