

# Liquid Argon TPC Detector R&D in USA

1. Introduction
2. US LArTPC programs
3. LAr photon detection R&D
4. Challenge of LArTPC technology
5. Conclusion

MicroBooNE PMT test stand  
(photo by Reidar Hahn, Fermilab)

Tepei Katori

Queen Mary University of London

UCL HEP seminar, University College London, London, Dec. 12, 2014

1. Introduction
2. US LArTPC programs
3. LAr photon detection R&D
4. Challenge of LArTPC technology
5. Conclusion

# 1. Liquid Argon Time Projection Chamber (LArTPC)

The principle of LArTPC  
- 3D track reconstruction

Bo Yu (BNL)

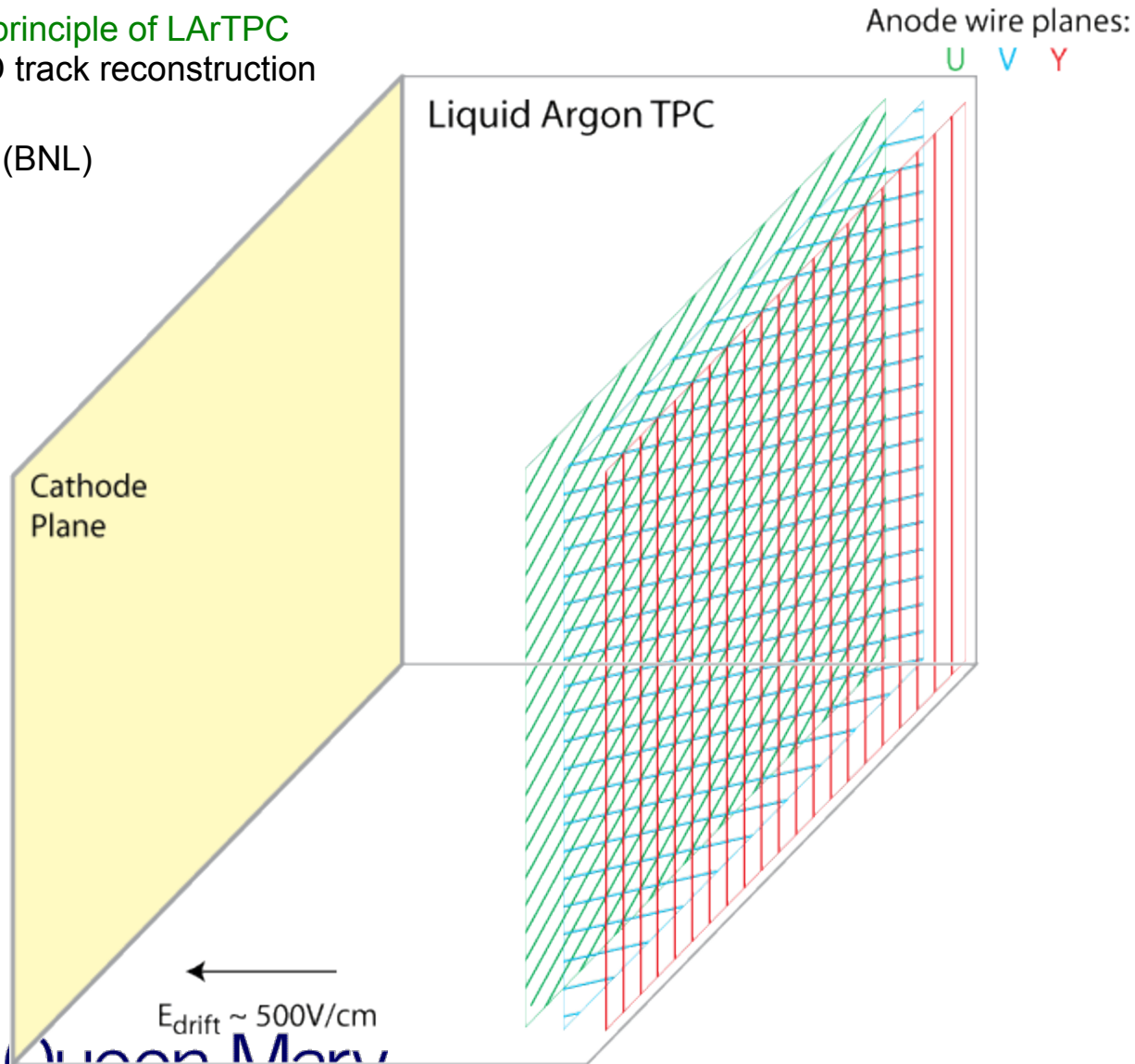

# 1. Liquid Argon Time Projection Chamber (LArTPC)

The principle of LArTPC  
- 3D track reconstruction

Bo Yu (BNL)

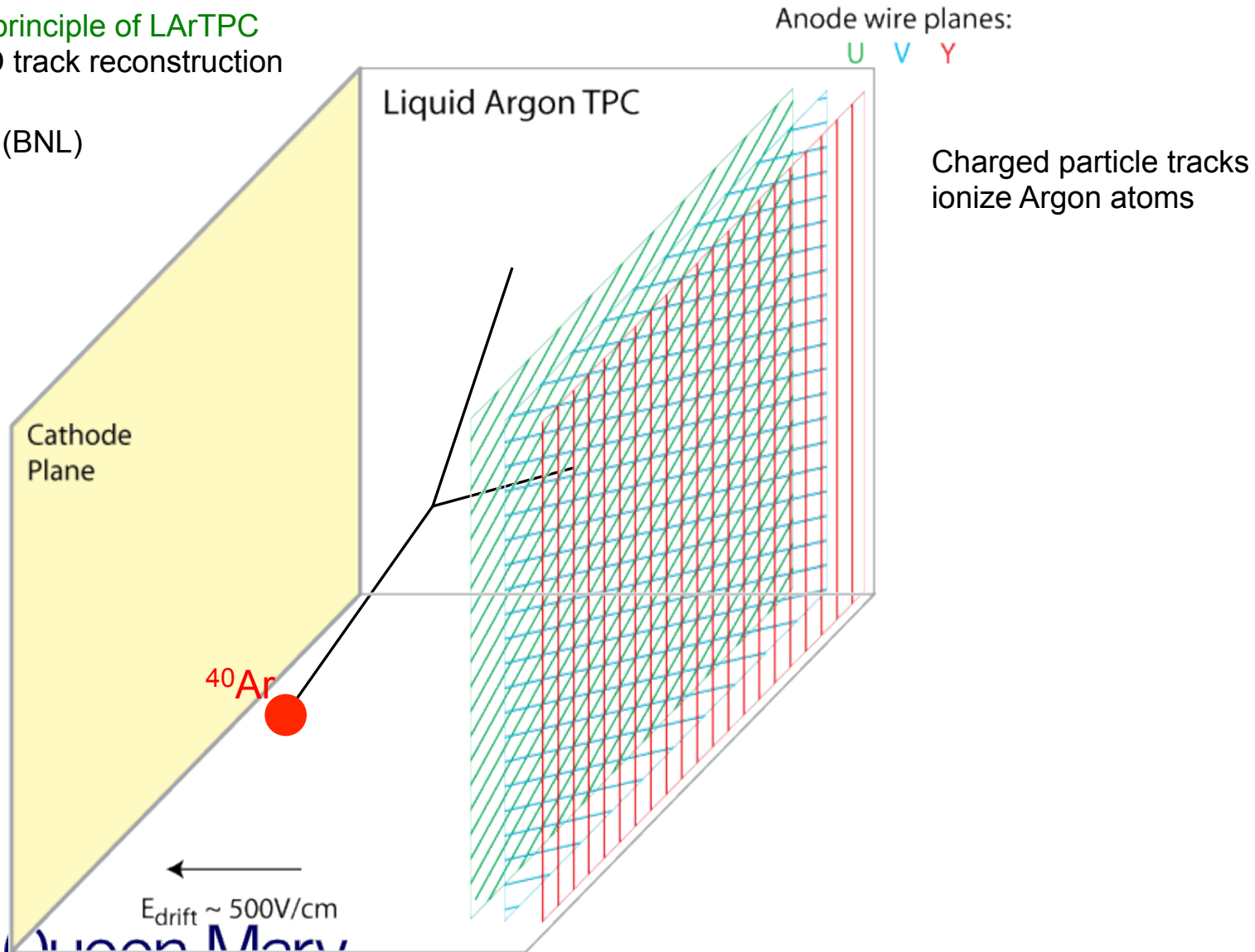

Charged particle tracks  
ionize Argon atoms

# 1. Liquid Argon Time Projection Chamber (LArTPC)

The principle of LArTPC  
- 3D track reconstruction

Bo Yu (BNL)

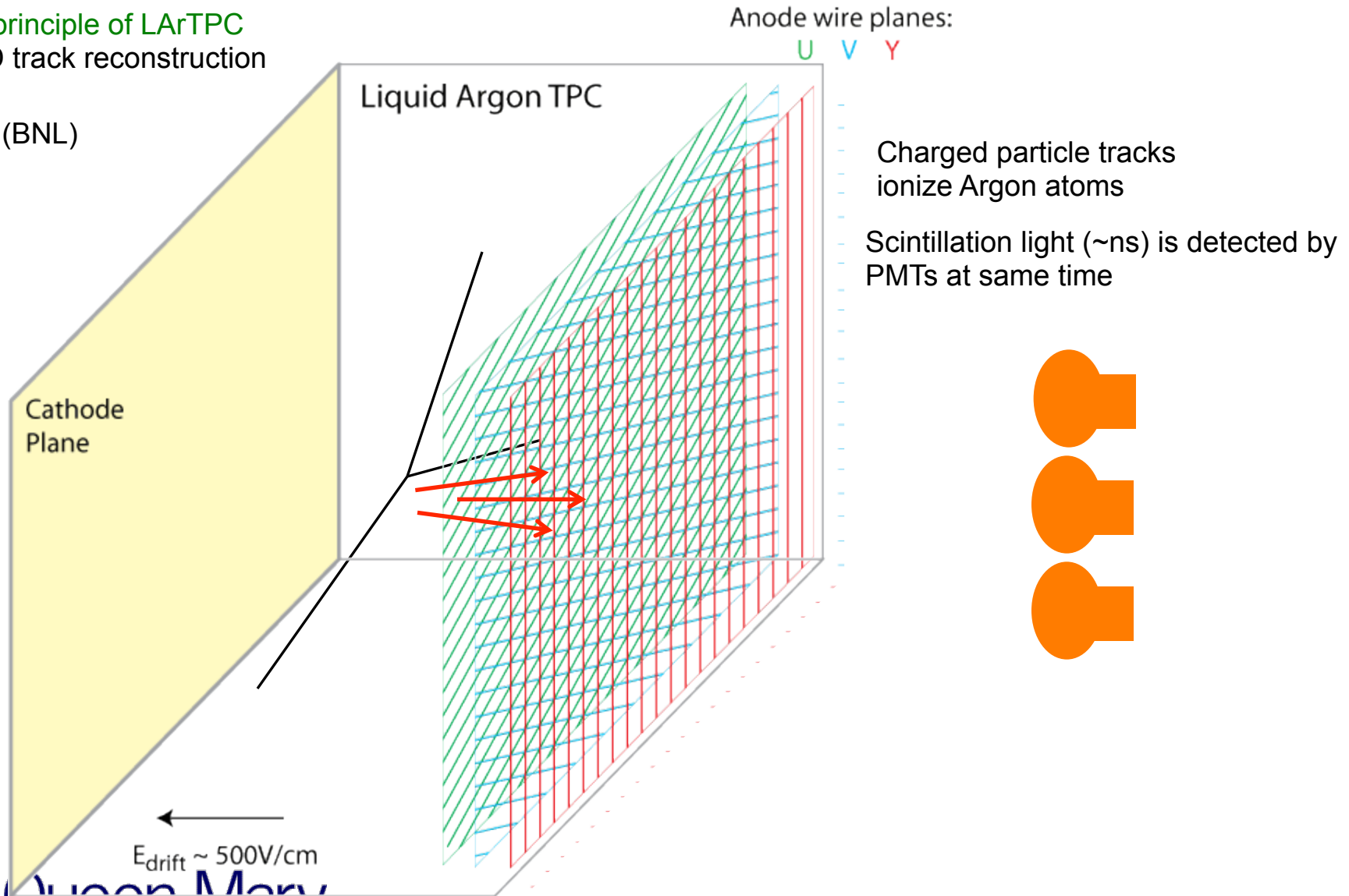

# 1. Liquid Argon Time Projection Chamber (LArTPC)

The principle of LArTPC  
- 3D track reconstruction

Bo Yu (BNL)

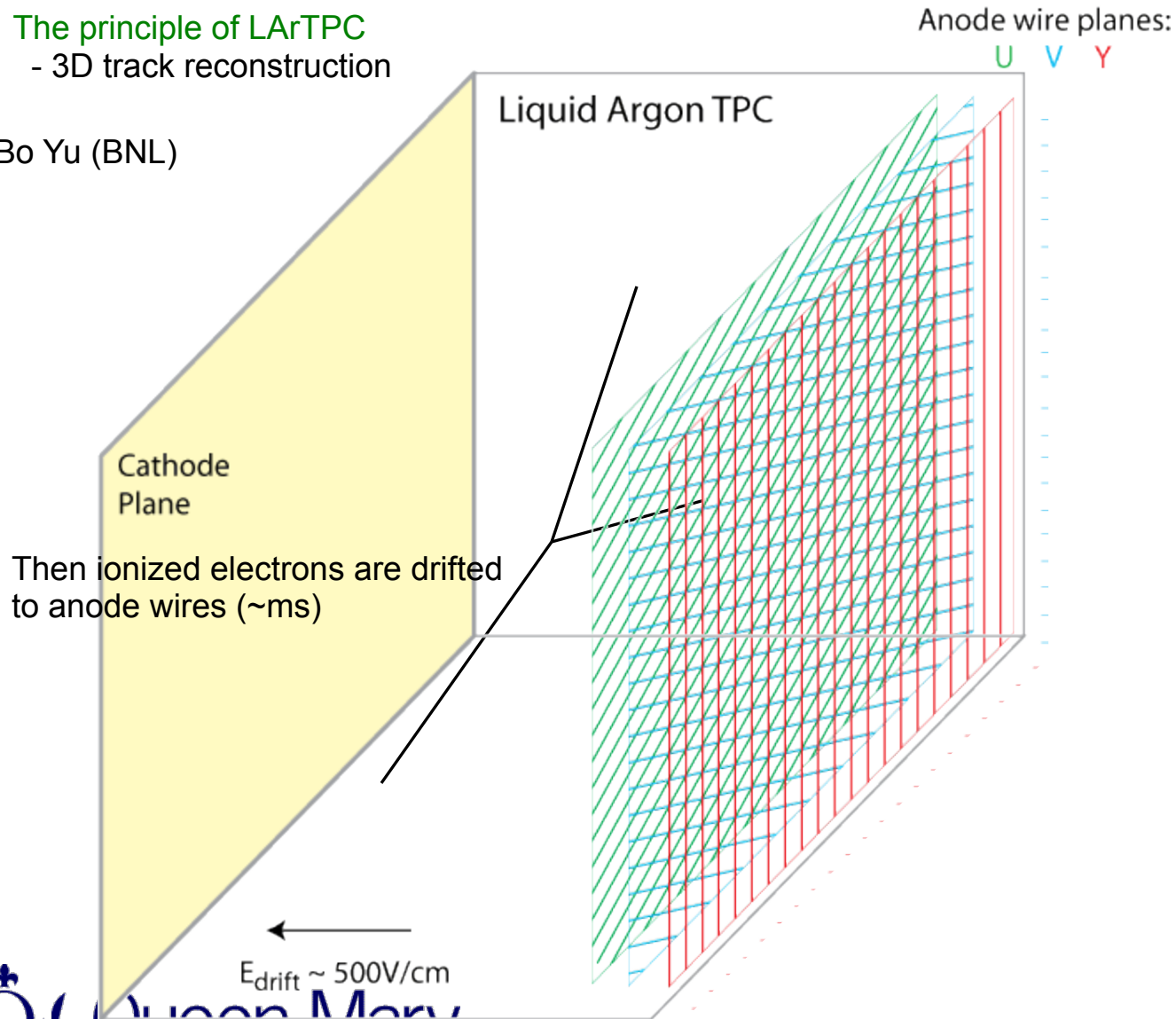

# 1. Liquid Argon Time Projection Chamber (LArTPC)

The principle of LArTPC  
- 3D track reconstruction

Bo Yu (BNL)

Liquid Argon TPC

Anode wire planes:

U V Y

Cathode Plane

Then ionized electrons are drifted to anode wires (~ms)

Electrons near the wires are collected first, and electrons far from the wires are collected last, so drift coordinate information is converted to electron drift time (time is projected)

$E_{\text{drift}} \sim 500\text{V/cm}$

Teppei Katori

time  
14/12/12

# Charge Signal Formation

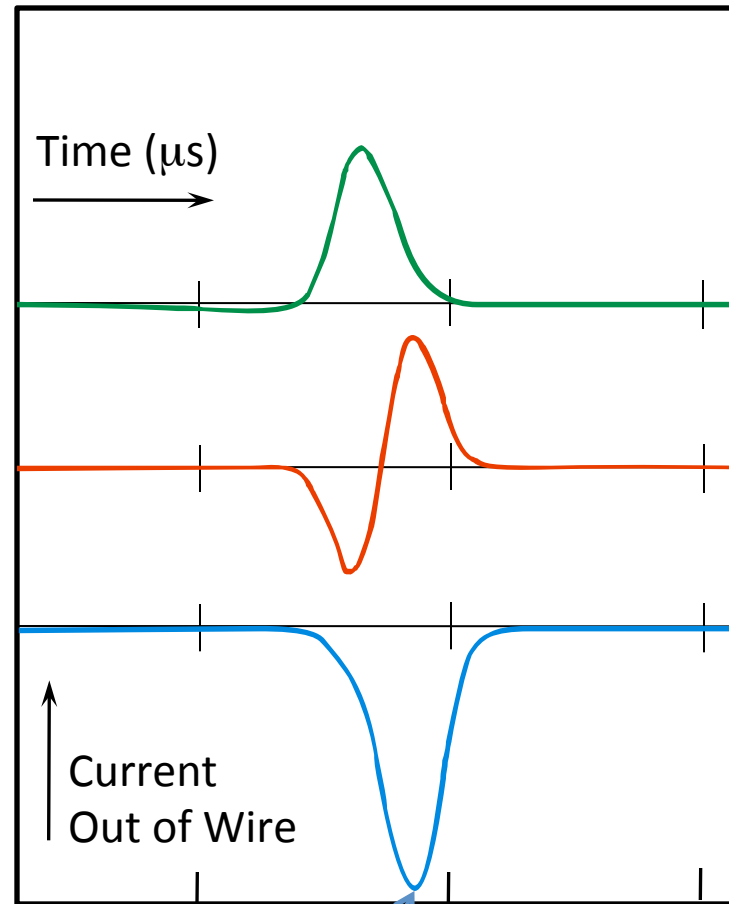
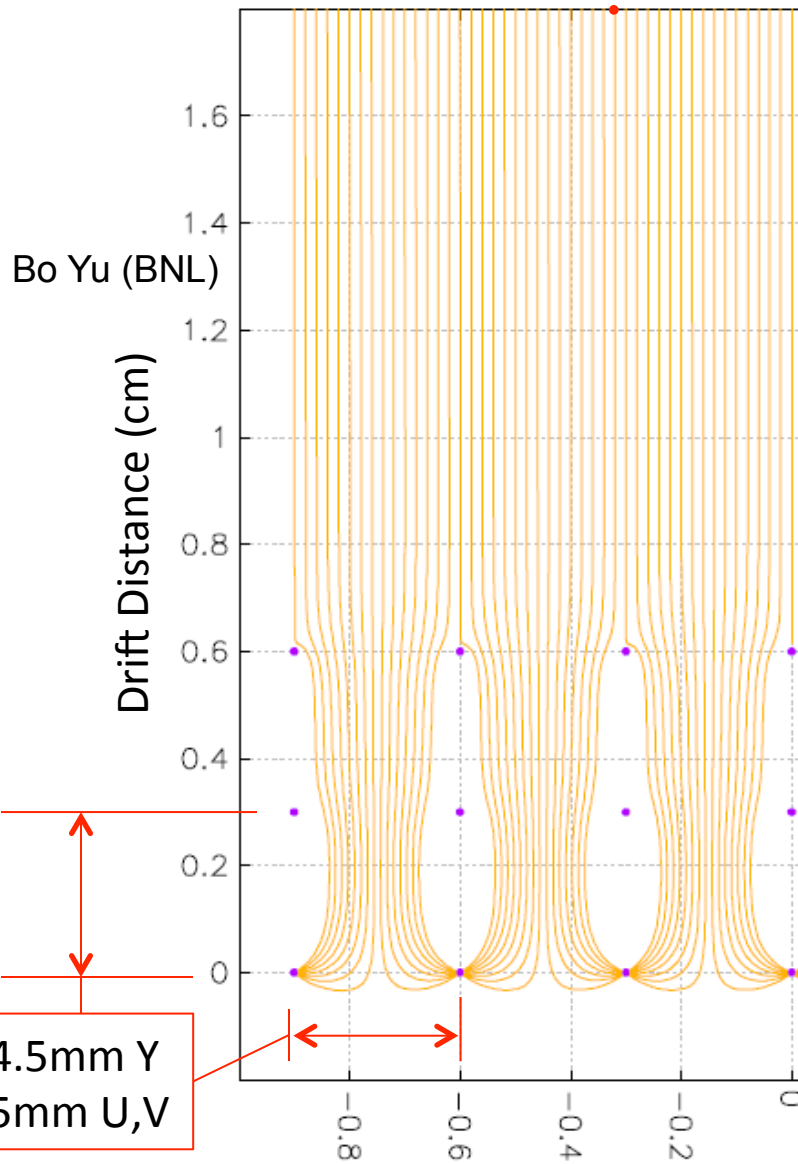

**U** Induction  
(small, bipolar)

**V** Induction  
(small, bipolar)

**Y** Collection  
(large, unipolar)

ArgoNeuT  
1 MIP peak  $\sim$  26 ADC counts  
Noise rms  $\sim$  1 ADC count



1. Introduction
2. USA LArTPC programs
3. LAr photon detection R&D
4. Challenge of LArTPC technology
5. Conclusion

## 2. USA LArTPC programs

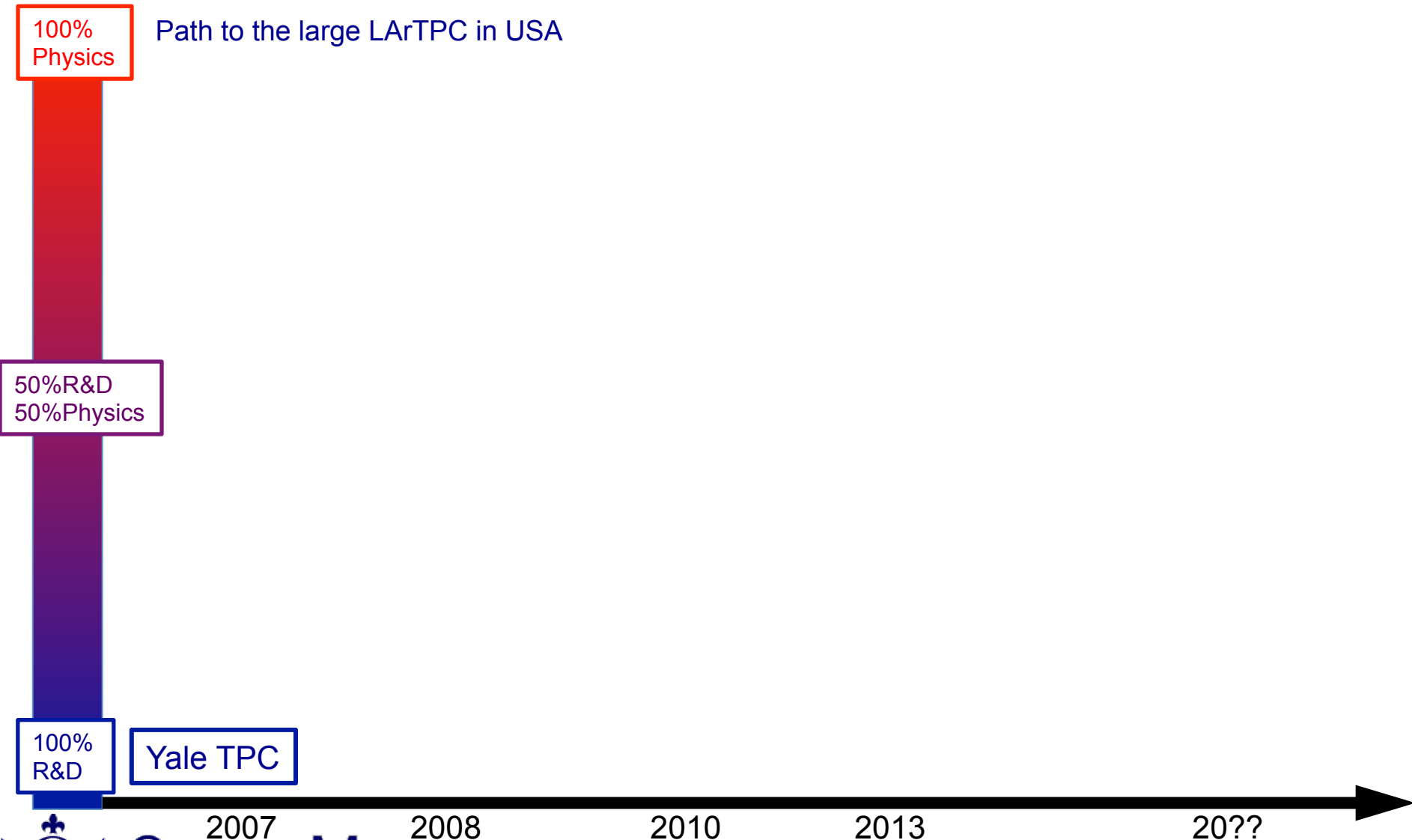

## 2. Yale TPC

TPC vessel sitting in LAr bath

- 2 plane reeading, 50 wires with 5 mm pitch
- LAr filter in line (ppm→few tenth of ppb)
- not cryostat, but TPC vessel is sitting in LAr bath

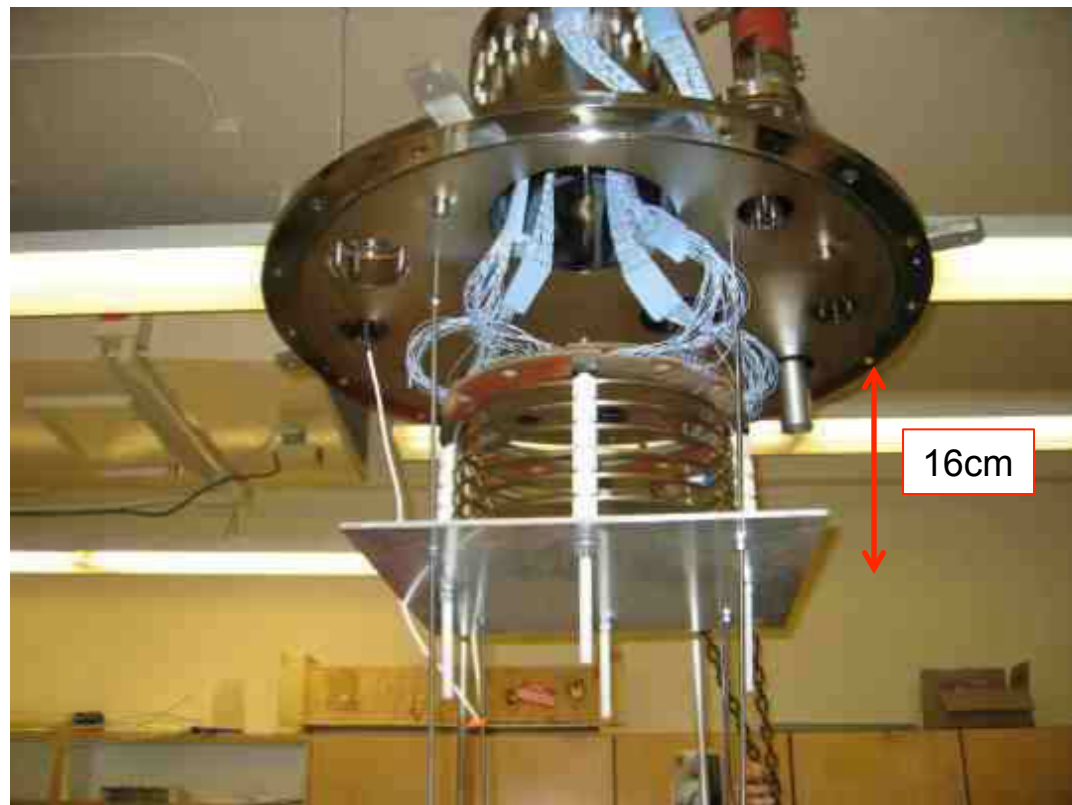

## 2. Yale TPC

TPC vessel sitting in LAr bath

- 2 plane reeading, 50 wires with 5 mm pitch
- LAr filter in line (ppm  $\rightarrow$  few tenth of ppb)
- not cryostat, but TPC vessel is sitting in LAr bath

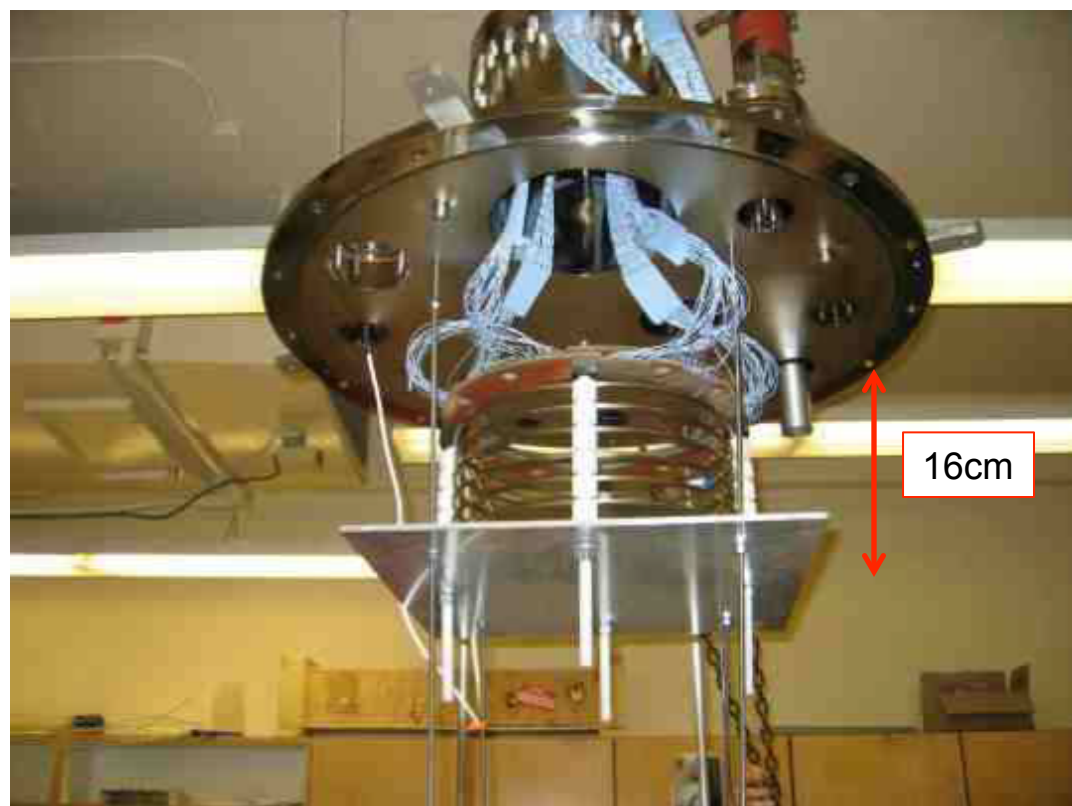
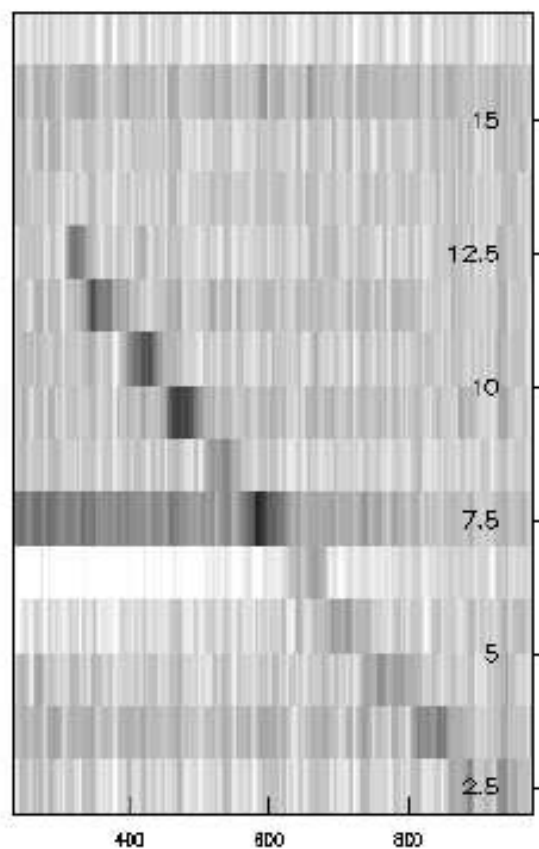

Figure 5. Muon crossing the TPC (collection view).

# 1. USA LArTPC programs

100%  
Physics

Path to the large LArTPC in USA

50%R&D  
50%Physics

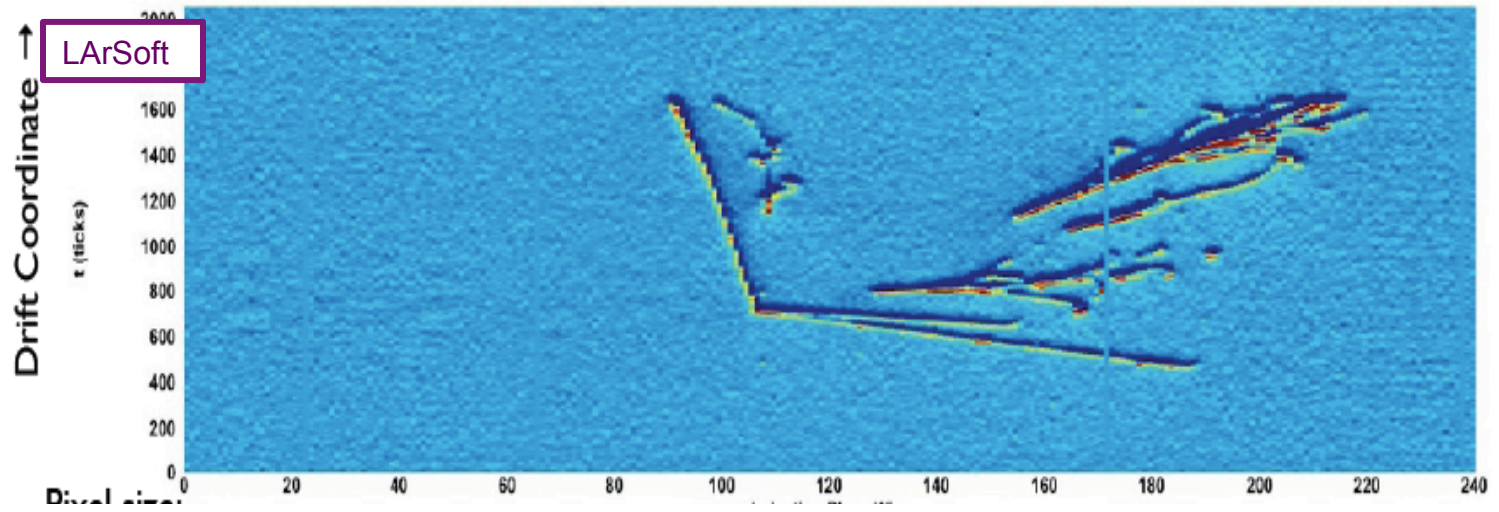

100%  
R&D

Yale TPC

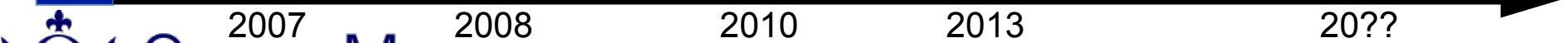

2007

2008

2010

2013

20??

## 2. LArSoft

Reconstruction is hard

- Biggest effort on software development
- Shower reconstruction is especially hard

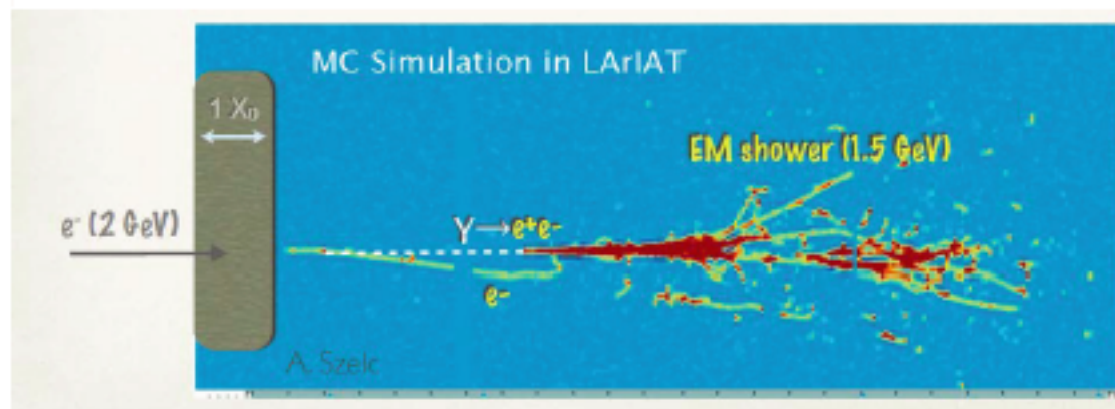
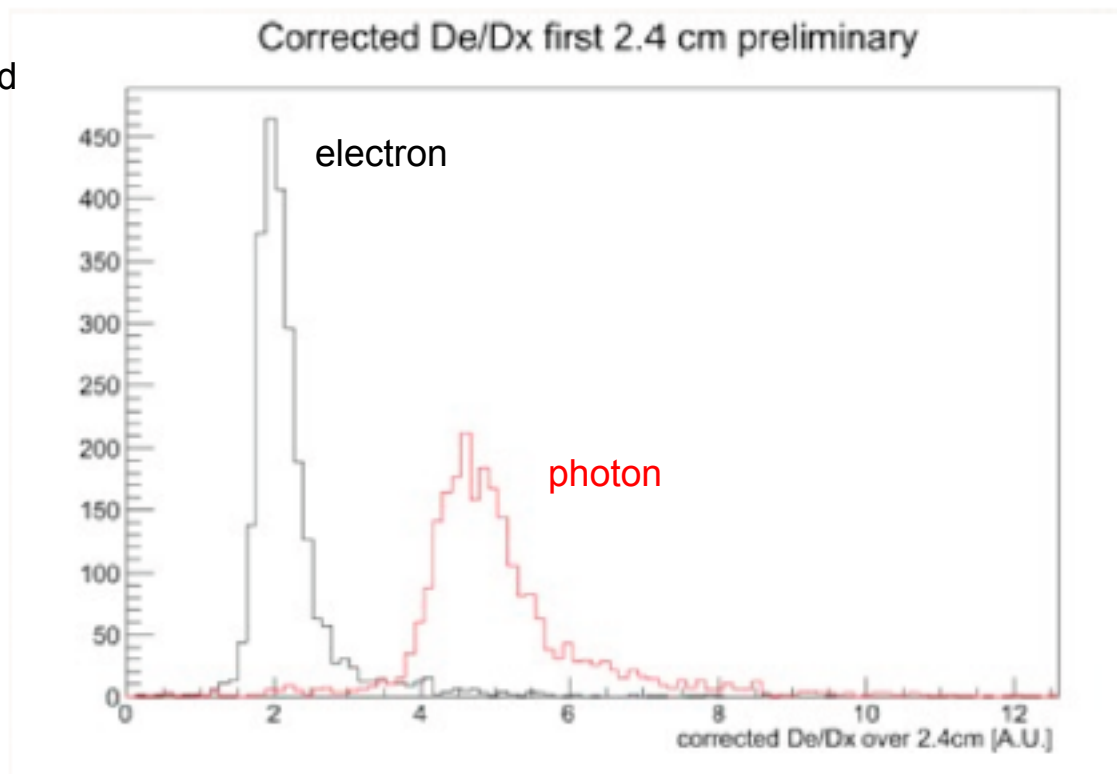

# 1. USA LArTPC programs

100%  
Physics

Path to the large LArTPC in USA

50%R&D  
50%Physics

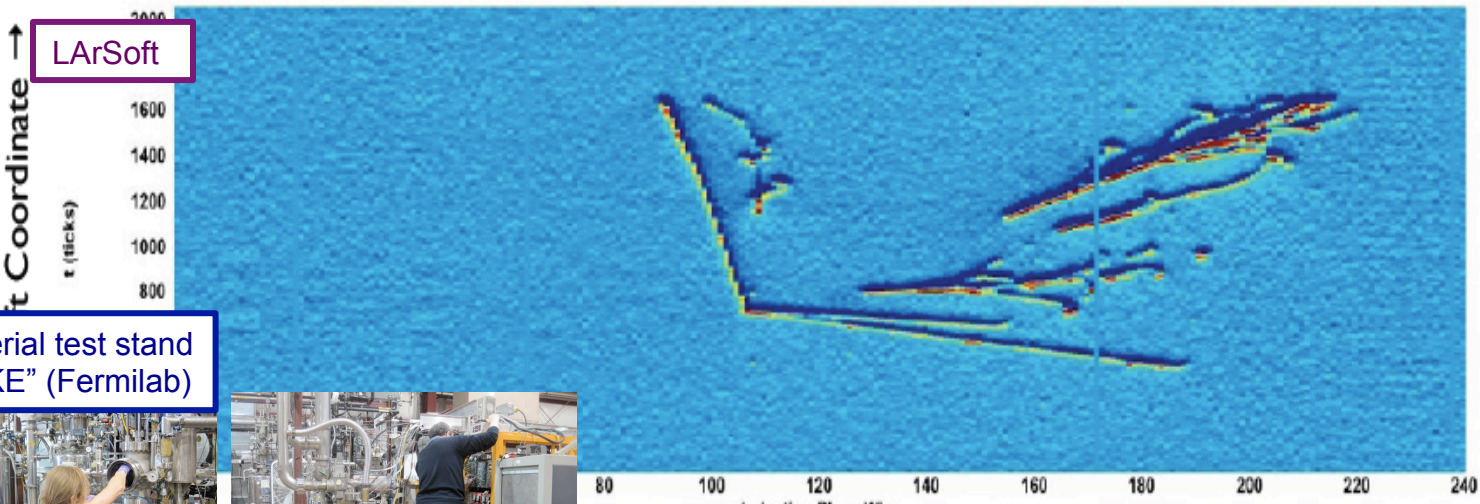

Material test stand  
"LUKE" (Fermilab)



100%  
R&D

Yale TPC

Electronics test stand  
"Bo" (Fermilab)

## 2. Argon purification system

- Measure pollution of LAr by materials
- ~tenth of ppt purity
- gas and liquid phase measurement

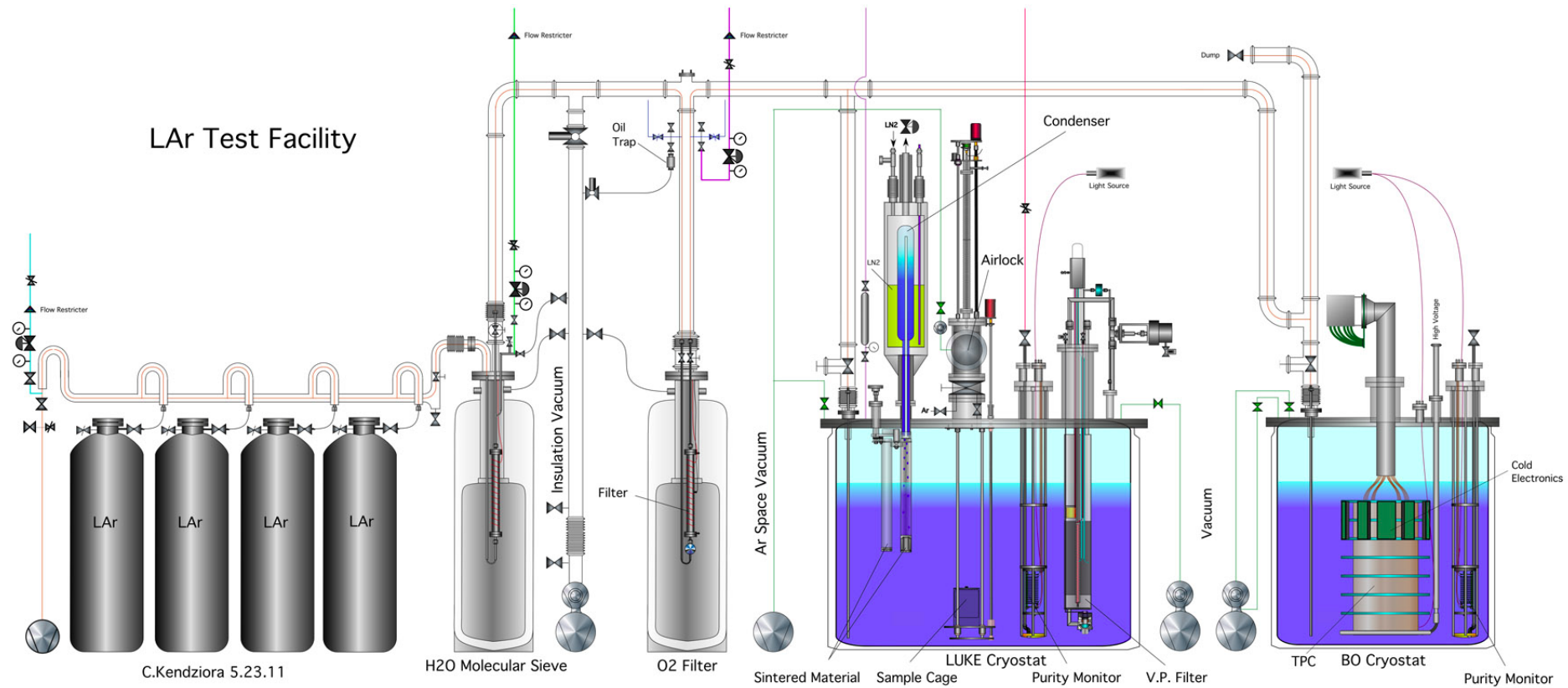

Argon purification system

Luke

Bo



## 2. Argon purification system

Measure pollution of LAr by materials

- ~tenth of ppt purity
- gas and liquid phase measurement



Argon purification system

Luke

Bo

## 2. Argon purification system

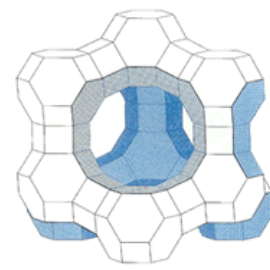

~600-1000m<sup>2</sup>/g

- Measure pollution of LAr by materials
- ~tenth of ppt purity
  - gas and liquid phase measurement

Sintered metal

H<sub>2</sub>O filter

Molecular sieve  
(zeolite)

O<sub>2</sub> filter

Activated copper  
coated alumina

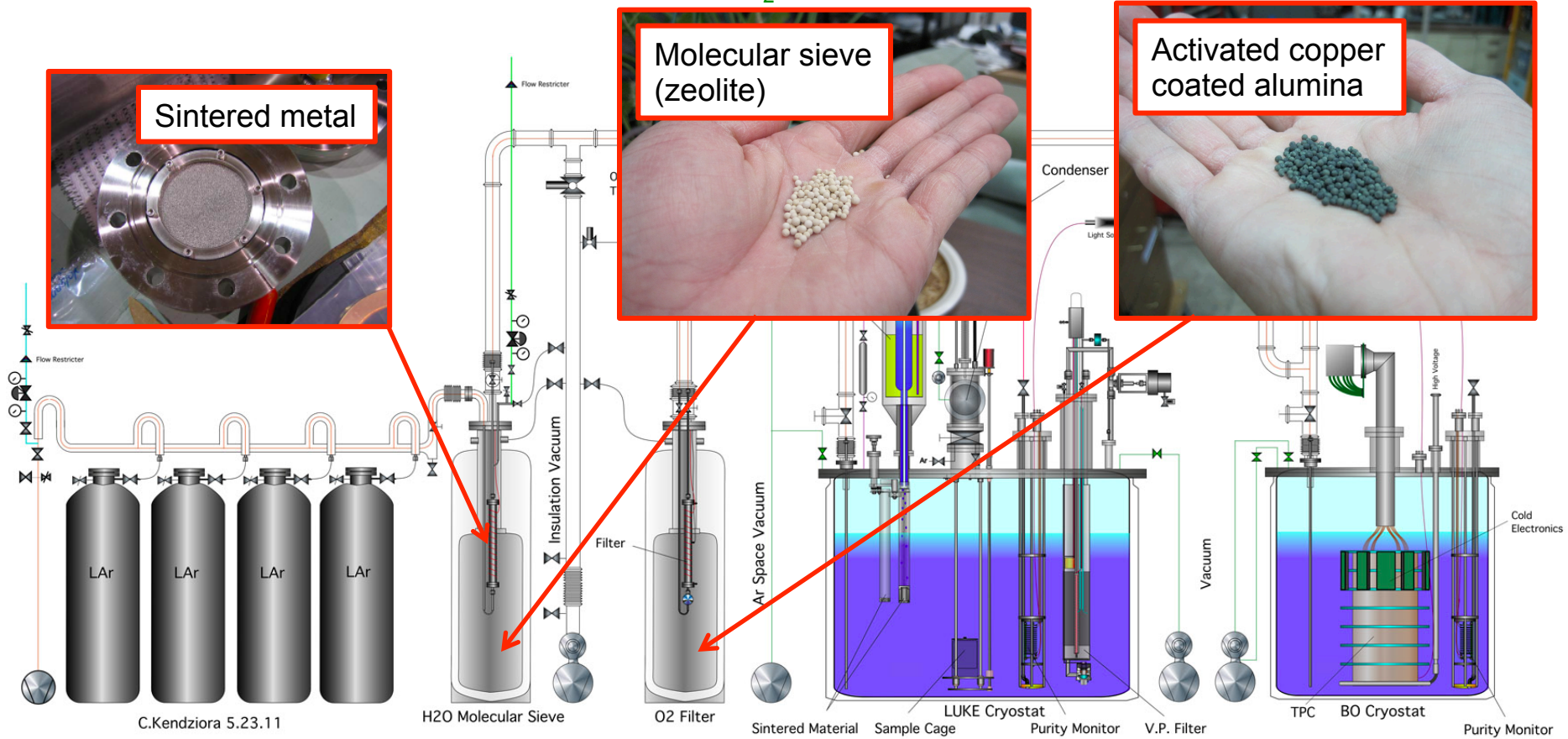

Argon purification system

Luke

Bo

## 2. Argon purification system

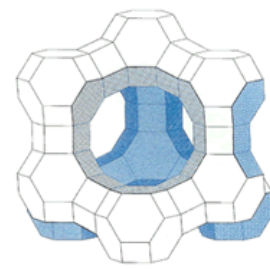

~600-1000m<sup>2</sup>/g

- Measure pollution of LAr by materials
- ~tenth of ppt purity
  - gas and liquid phase measurement

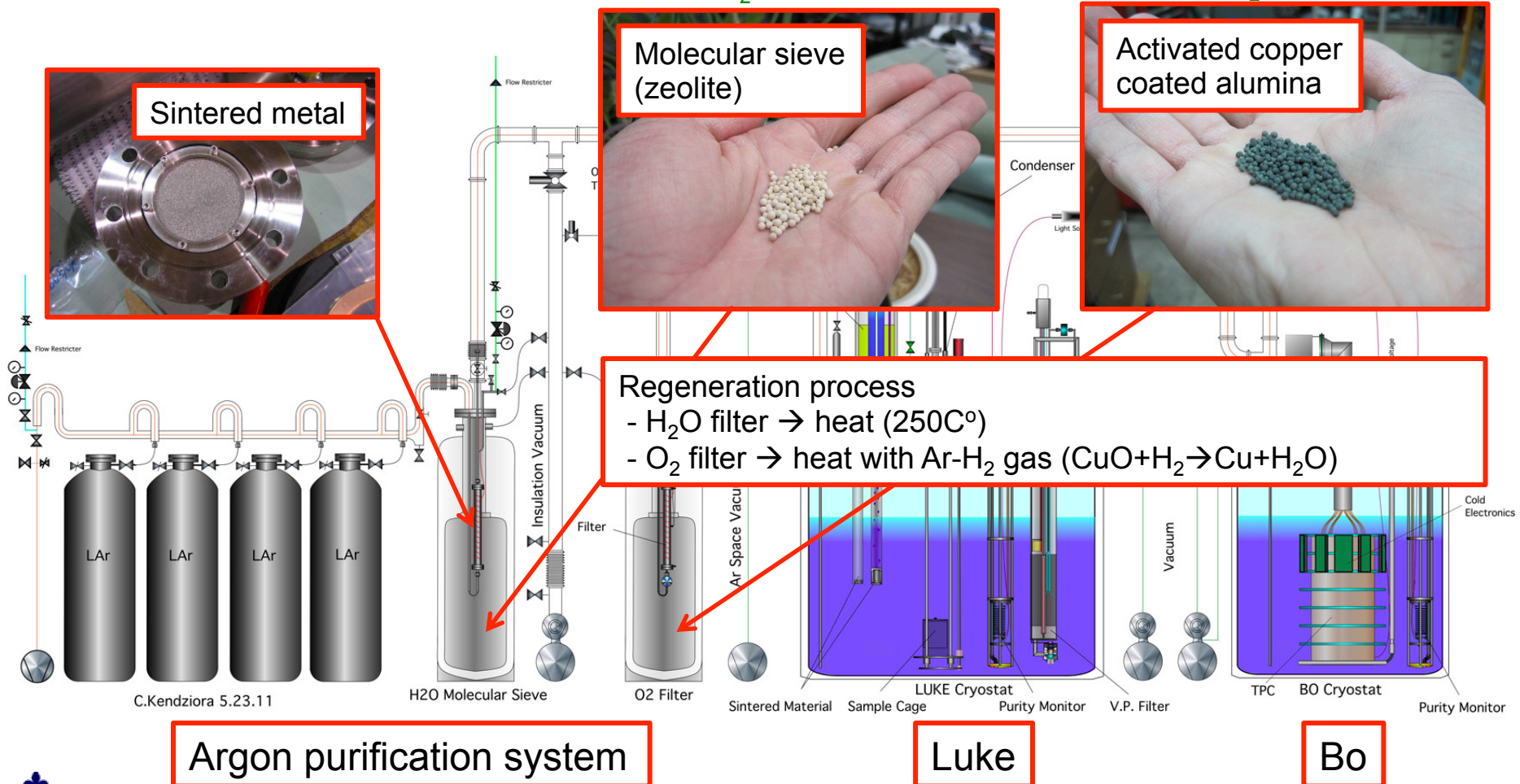

## 2. Materials Test System (MTS), “Luke”

250L cryostat

- All materials used in inside of LArTPC cryostat must be tested by this (ArgoNeuT, MicroBooNE, etc)
- Measure the change of electron lifetime (=impurity concentration) by material insertion
- Both gas and liquid phase

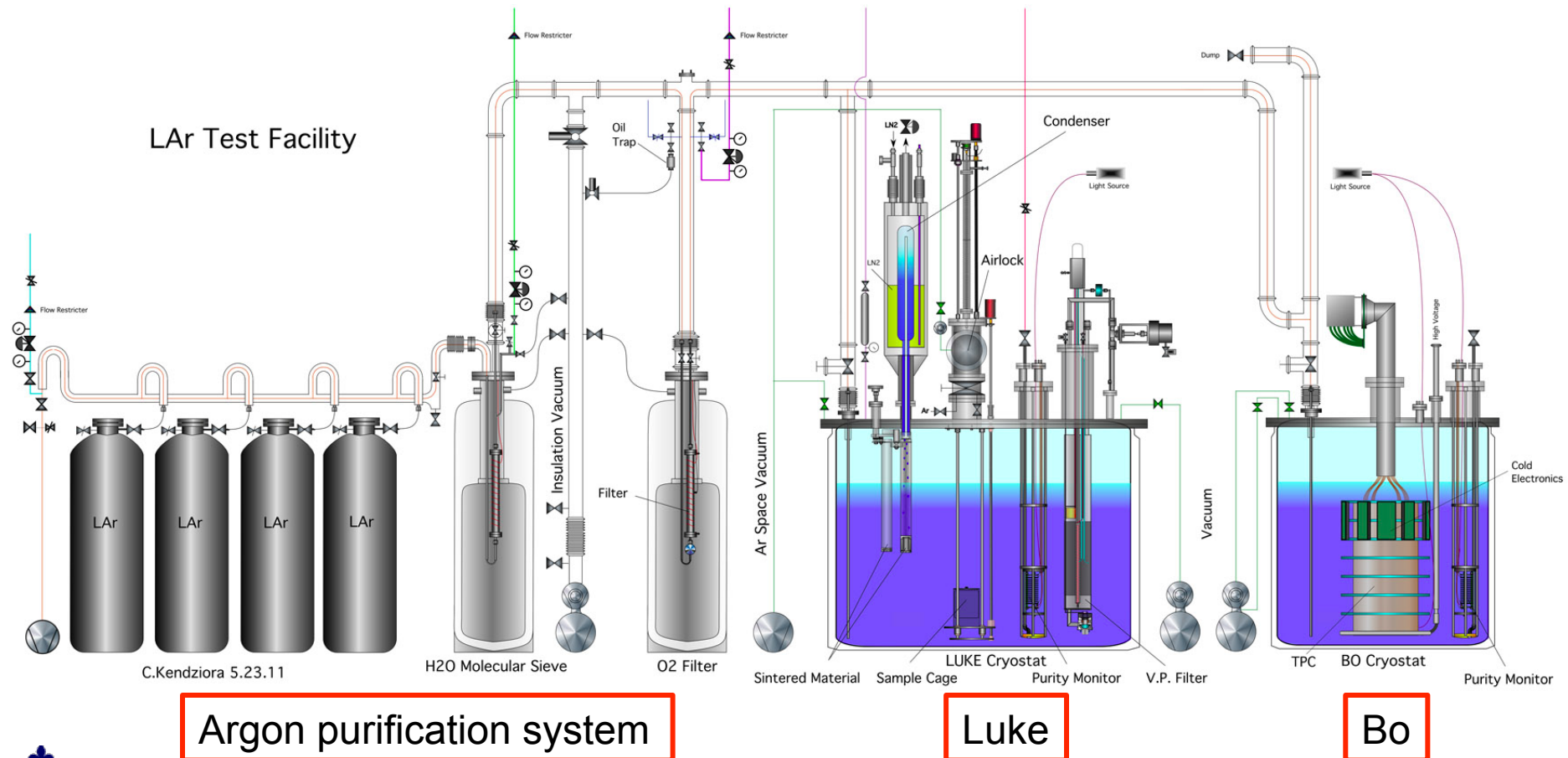

## – Materials Test System

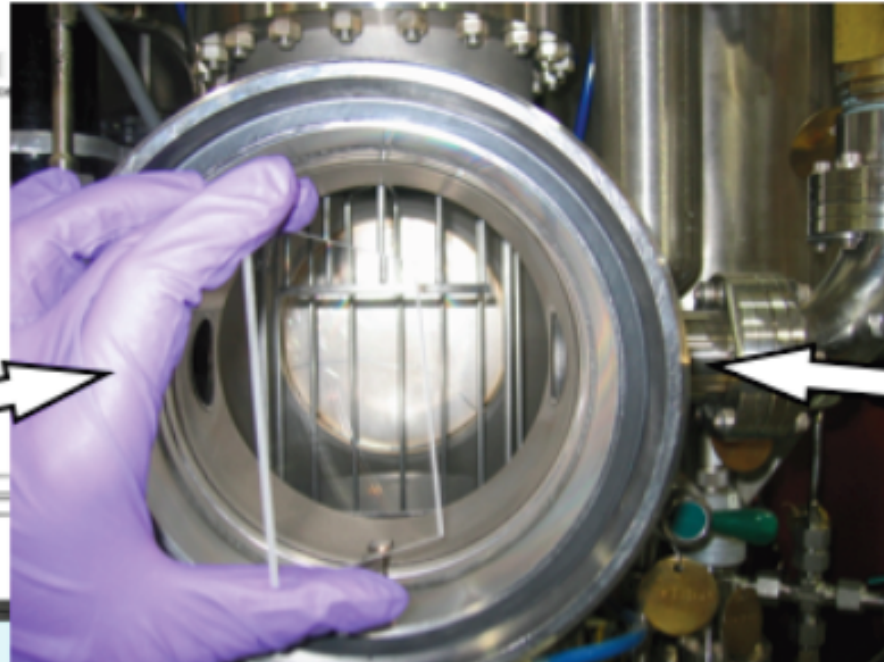
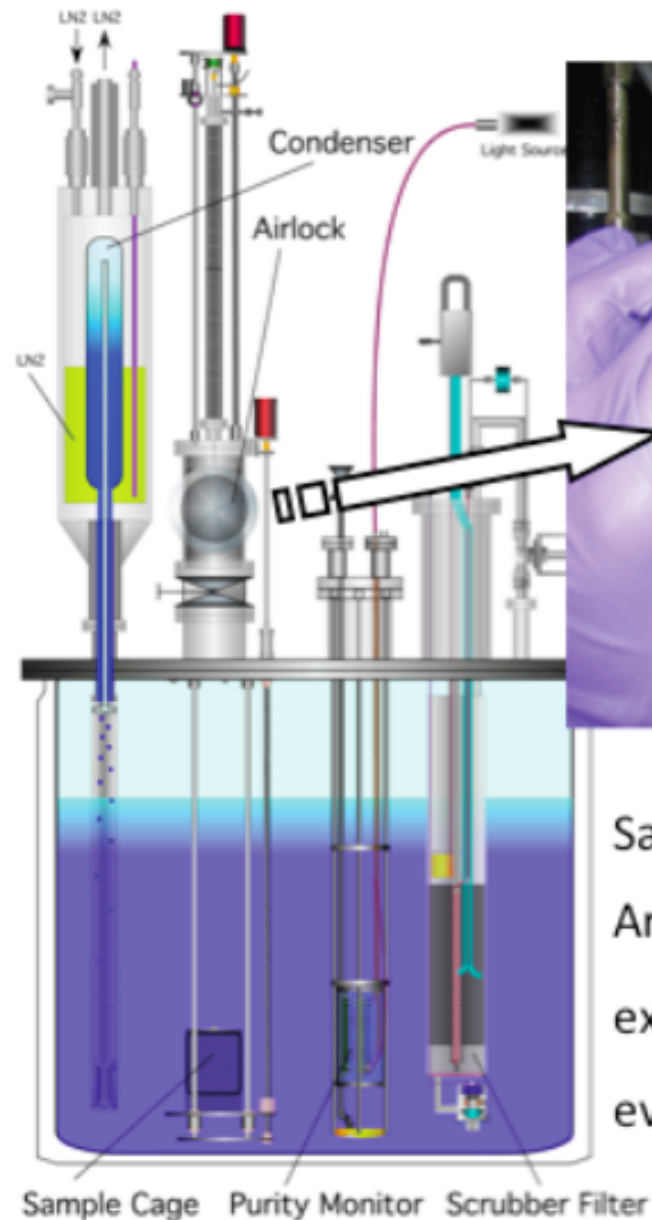

Sample volume 10 cm x 10 cm x 10 cm  
Argonlock can be purged with  
external argon, cryostat argon, and/or  
evacuated

## 2. Materials Test System (MTS), "Luke"

Purity monitor

- Produce photo-electron by imping UV light on gold plate
- Cathode and anode signal define electron life time

$$Q_{\text{anode}}/Q_{\text{cathode}} = e^{-t_{\text{drift}}/\tau}$$

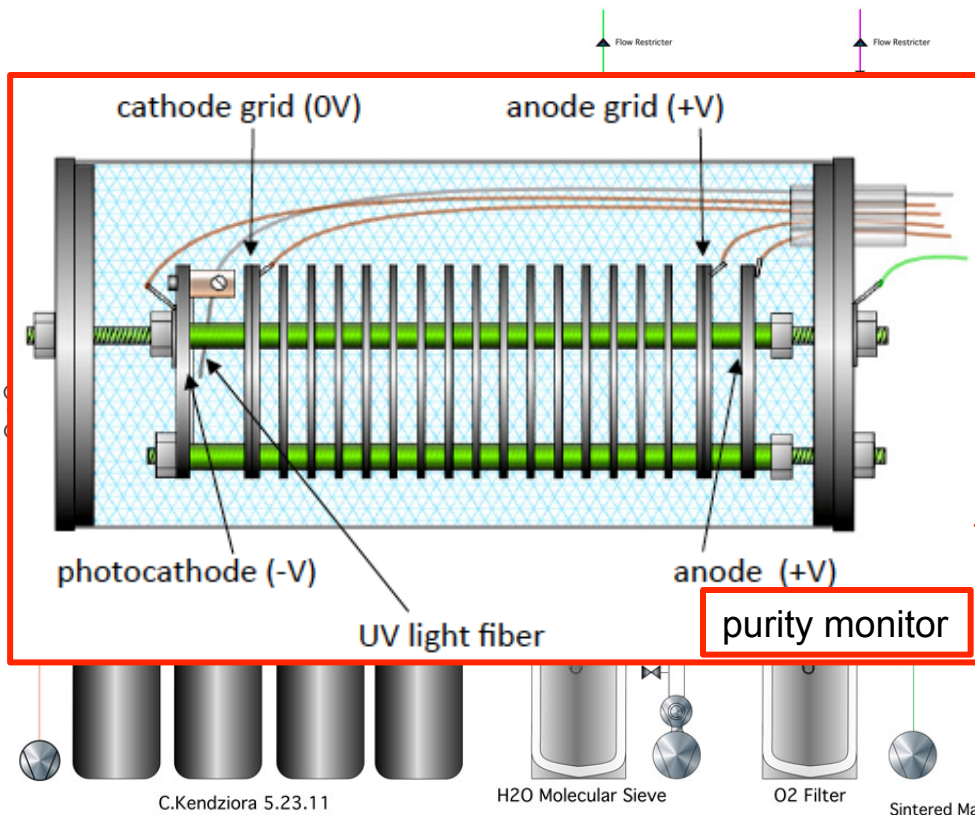

Argon purification system

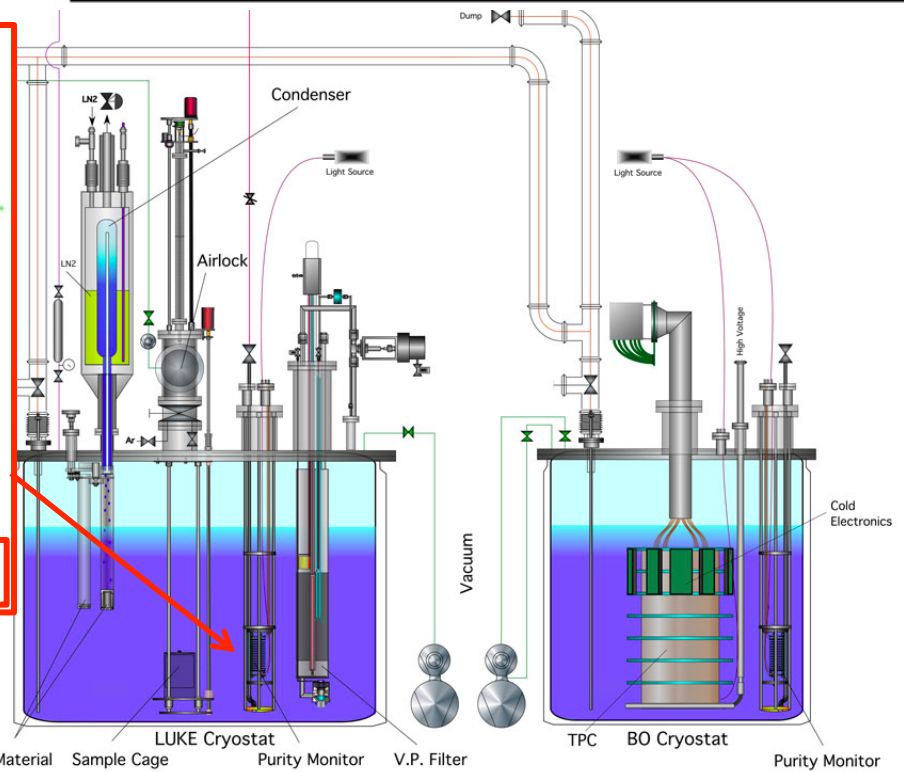

Luke

Bo

## 2. Materials Test System (MTS), “Luke”

FR4 (typical circuit board material)

- fiber glass (=contain lots of water), known “bad” material for LArTPC
- Impurity ceases to show up, it only appear gas phase running

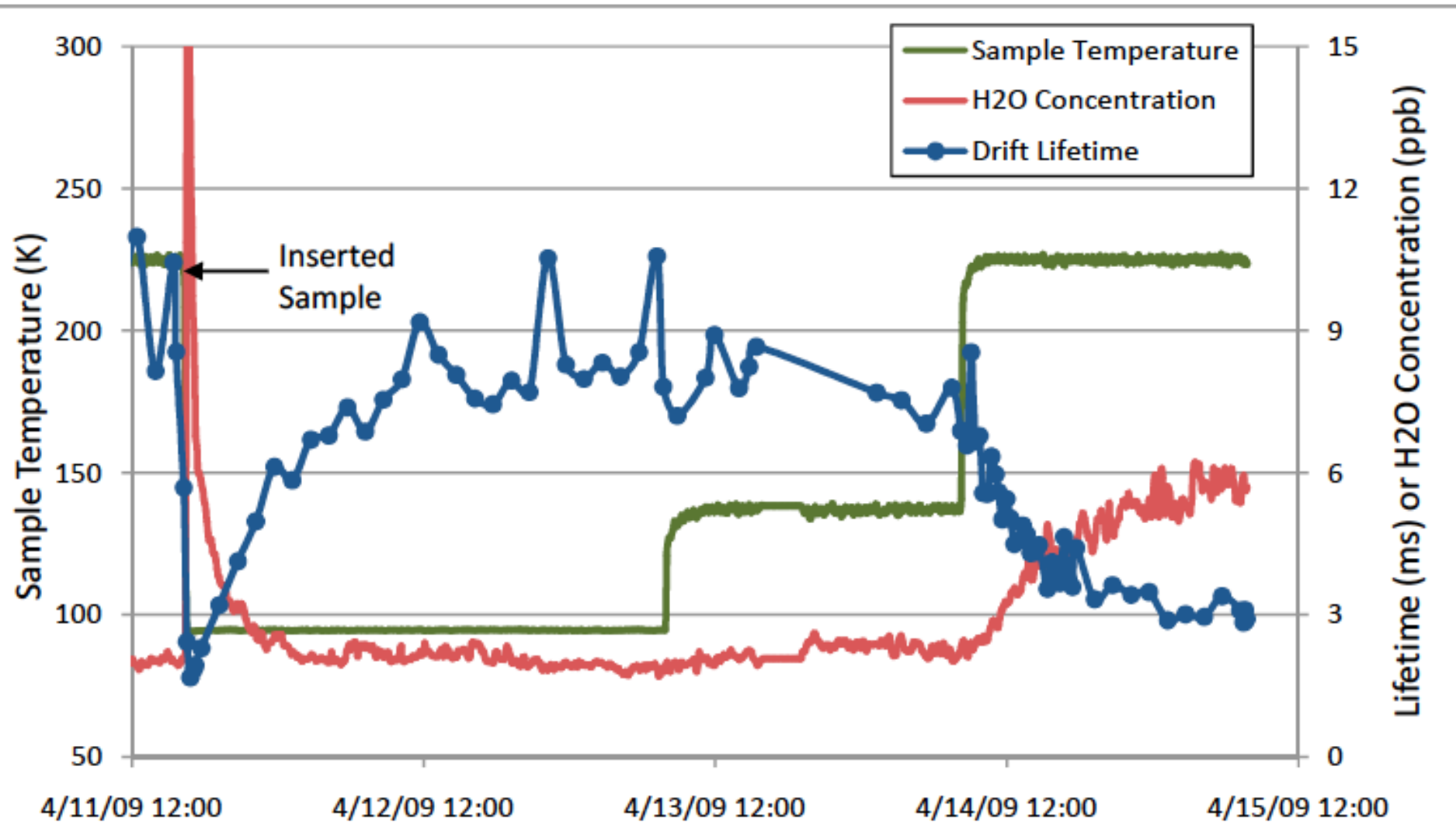

## 2. Materials Test System (MTS), “Luke”

FR4 (typical circuit board material)

- fiber glass (=contain lots of water), known “bad” material for LArTPC
- Impurity ceases to show up, it only appear gas phase running
- there is no material reduce electron life in liquid (problem happens when material is exposed in LAr gas)

Material	Date test started	Preparation	Tests	Water [ppb]	Lifetime [ms]	LogBook #
Cleaning Solution	6/29/09	evac. 24 h	vapor/liquid	4	5	946
Vespel	7/9/09	evac. overnite	liquid/vapor	5-7	2-5, 4-6	960
MasterBond glue	7/16/09	purged 18 h	vapor/liquid	1.6	1.3- 2.9	974
LEDs	7/31/09	purged 38 h	vapor	3.5	5	993
Carbon filter material	8/12/09	evac. 24 h	liquid/vapor	2	4-9	1000
962 FeedTru Board V2	10/12/09	evac. 24 h	vapor/warm	85	1-5	1062
Teflon cable	1/9/10	purged 28 h	warm/liquid/vapor	8-20	2-5	1175
3M "Hans" connectors	1/29/10	purged 46 h	warm/liquid/vapor	5-12	3	1198
962 capacitors	3/2/10	evac. 24 h	warm/liquid/vapor	6-14	3-6	1228
962 polyolefin cable	4/12/10	evac. 16 days	warm	25-60	2	1237
Rigaku feedthrough	4/20/10	purged 7.5 h	warm	15	3	1250
Rogers board (Teppei)	4/23/10	purged 26 h	warm/liquid/vapor	40	2, 6-10	1254
Arlon Board (Teppei)	5/14/10	evac. 0.5 h, pur.2 days	warm/vapor	300, 80	1.3, 3.5	1263
Polyethylene tubing	5/24/10	evac. 6 h, pur. 66 h	warm	300-500	1	1278
Teflon tubing	5/27/10	evac. 1 h, pur.17 h	warm	9-13	4-5	1283
Jonghee board	5/28/10	evac. 6 h, pur. 1.5 h	warm/vapor	100,28	1.2, 5-8	1285
Jonghee connectors	6/4/10	evac. 3.5 h, pur. 16 h	warm/vapor	50	2-3	1290
PVC cable	6/14/10	evac. 29 h, pur.1 h	warm	120	1-2	1296
Teppei TPB samples	8/3/10	purged 26 h	warm	600-1600	0.7	1342
Teppei TPB samples	9/4/10	purged 37 h	liquid /vapor	15, 300	6	
PrM feed tru (baked)	10/5/10	purged 25 h	warm/vapor	35, 20	3, 2	1396
Copper foil on mylar film	10/14/10	purged 26 h	warm/liquid/vapor	15, 10, 9	3, 8, 7	1409
Teppei SHV connector	10/25/10	purged 25 h	warm/vapor/liquid	35, 11, 0	2, 6, 6	1415
FR4	11/16/10	purged 25 h	warm/liquid/vapor	180, 20, 65	1.5, 6, 2.5	1429
Gaskets	3/11/11	purged 24 h	warm/liquid/vapor	8, 10	2.5, 8, 7	1521
LBNE AP-219 Color. Developer	4/13/11	purged 25 h	warm/vapor	65, 15	4, >6	1722
LBNE RPUF Foam	4/22/11	evac. 26 h, pur.1 h.	warm	800	0.2	1729
LAPD LEDs	5/12/11	purged 49 h	vapor	0.6 ppb	10	1769



# 2. Electronics test stand, “Bo”

General purpose R&D cryostat

- Test “cold” electronics
- Take cosmic ray data (filter function for Fourier transformation)
- Scintillation light test stand (later)

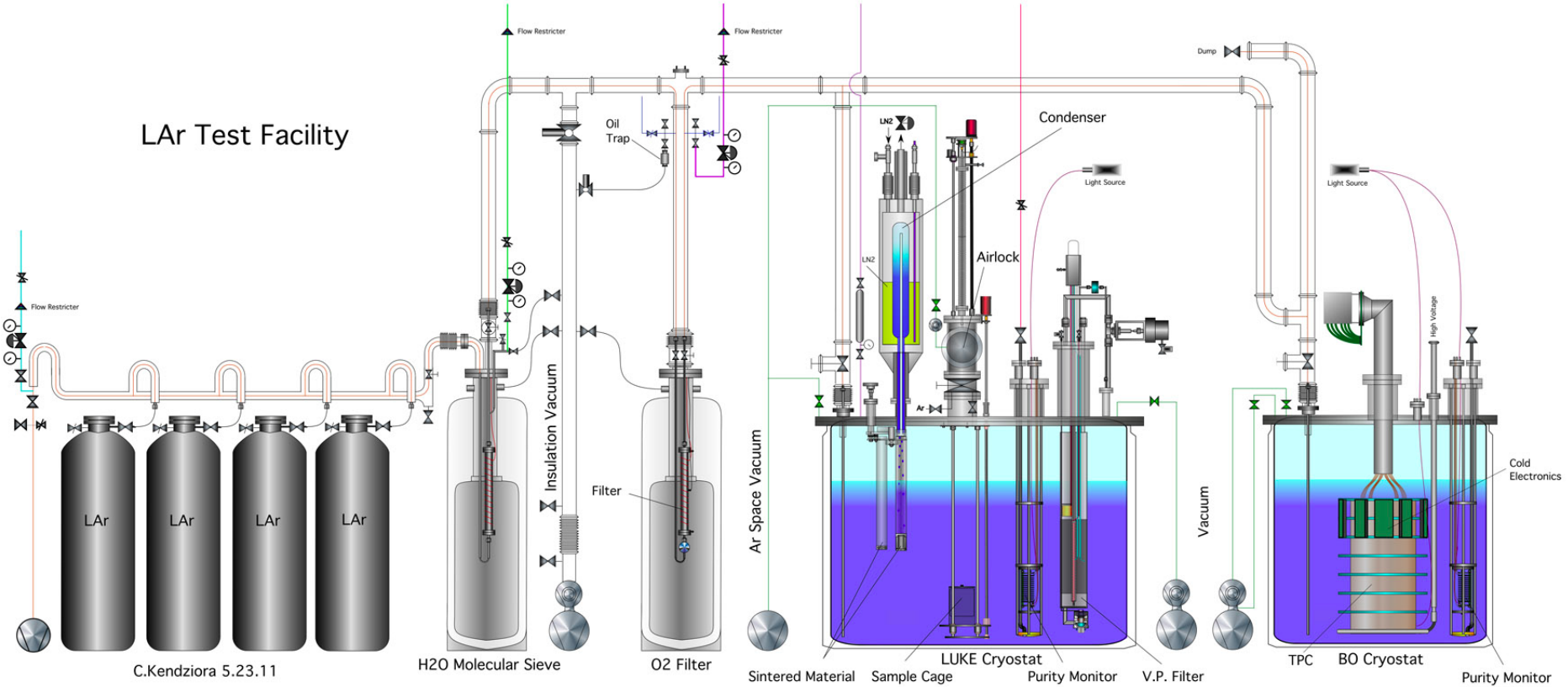

Argon purification system

Luke

Bo

# 1. USA LArTPC programs

100%  
Physics

Path to the large LArTPC in USA

50%R&D  
50%Physics

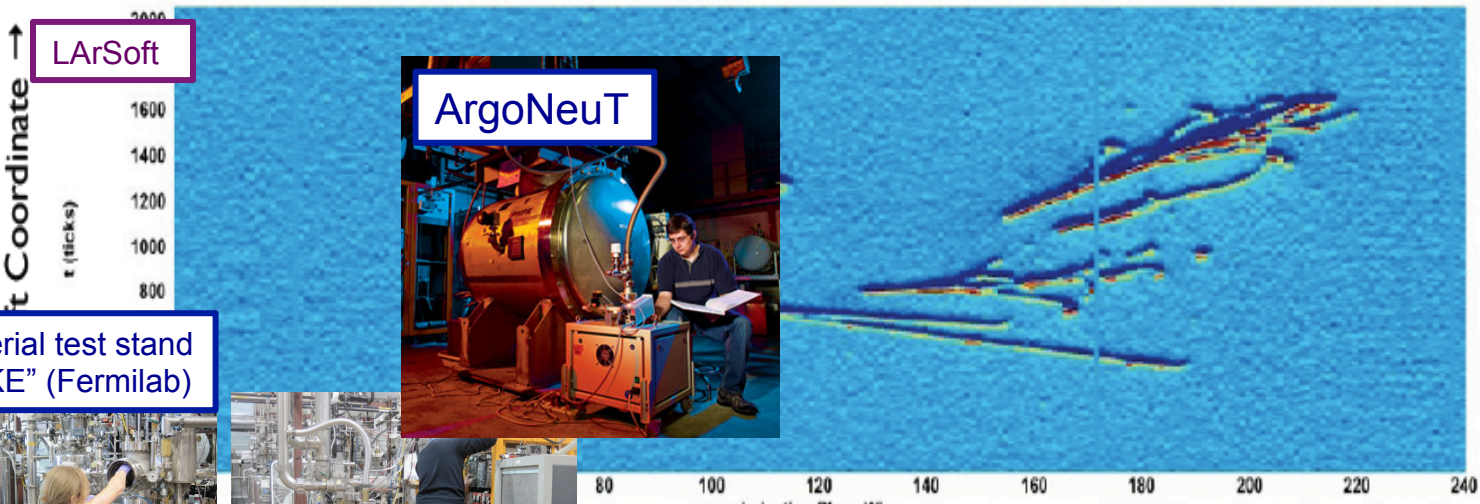

Material test stand  
"LUKE" (Fermilab)



Electronics test stand  
"Bo" (Fermilab)

100%  
R&D

Yale TPC

2007      2008      2010      2013      20??

## 2. ArgoNeuT

First USA LArTPC neutrino experiment

- Small fiducial volume, but MINOS ND as muon range
- NuMI neutrino beamline (wideband 3 GeV beam with tail up to 20 GeV)

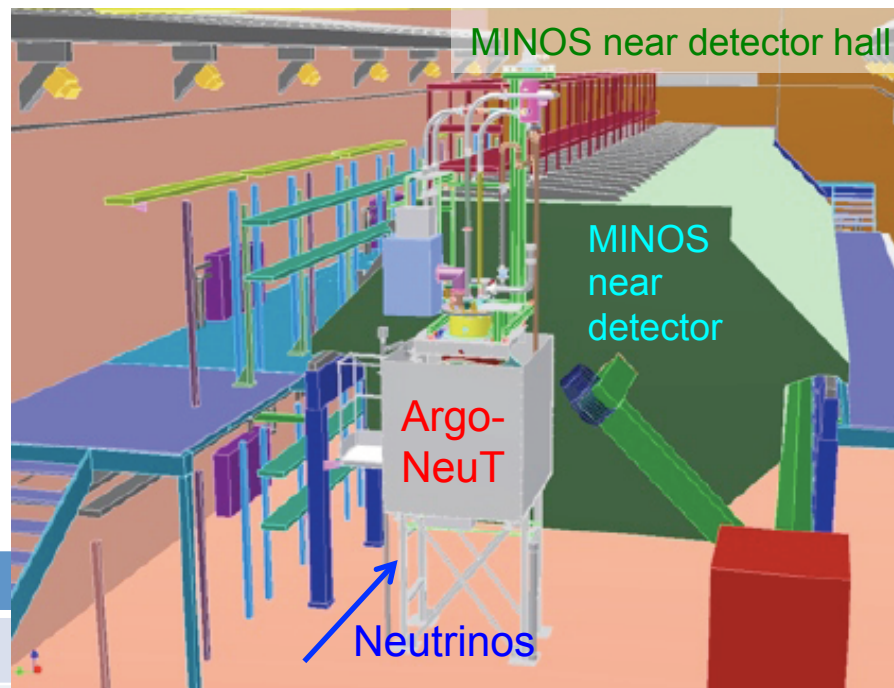

	ArgoNeuT
cryostat volume	0.7 ton
TPC volume	0.25 ton
# channel	480
wire pitch	4 mm
electronics style	JFET (293K)
max. drift length	0.5m (330ms)
light collection	none

## 2. ArgoNeuT

First USA LArTPC neutrino experiment

- Small fiducial volume, but MINOS ND as muon range
- NuMI neutrino beamline (wideband 3 GeV beam with tail up to 20 GeV)

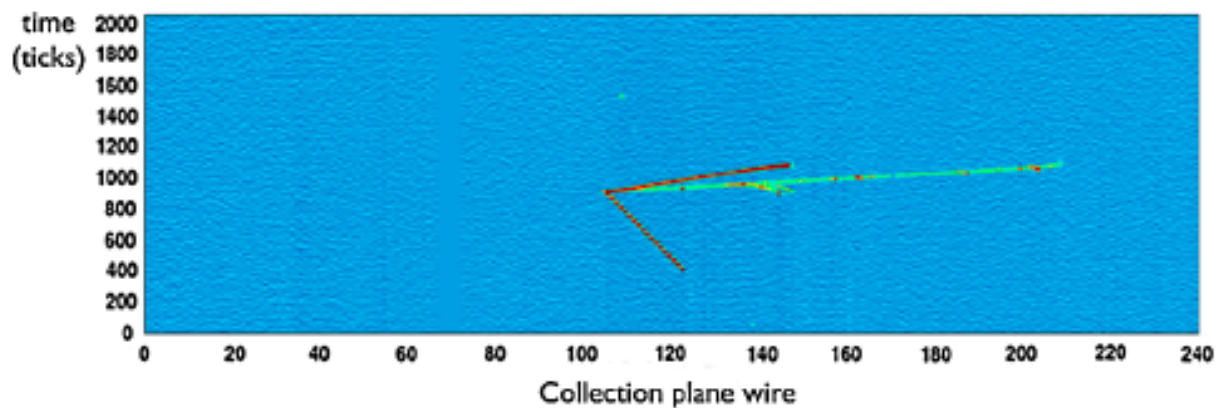
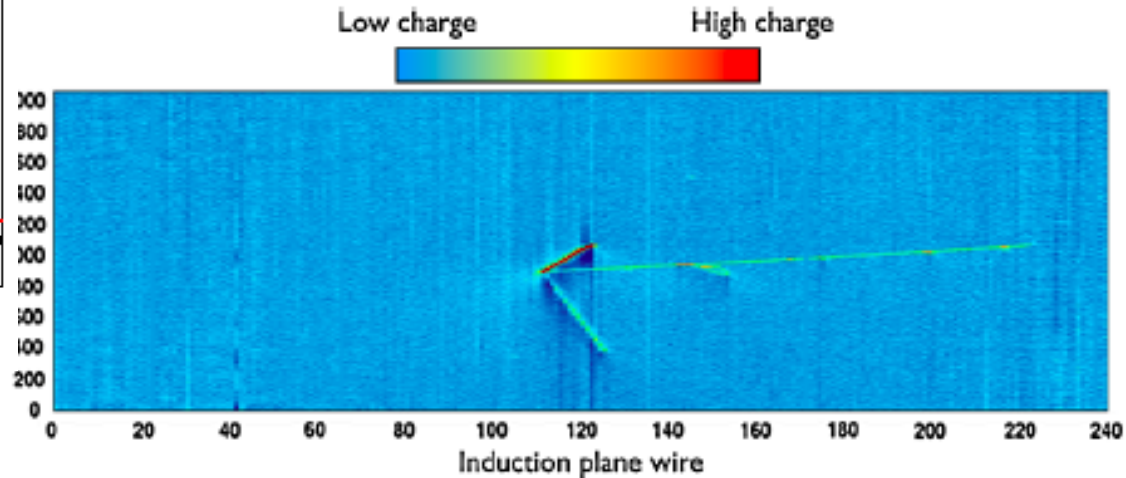
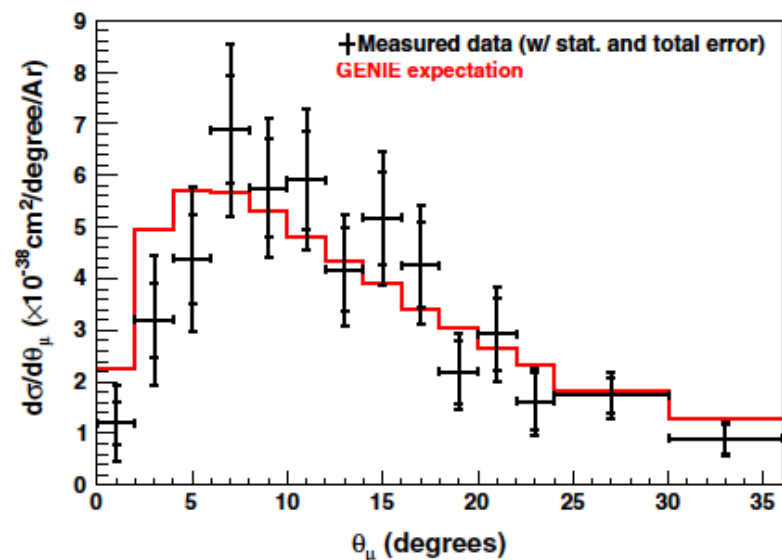

	ArgoNeuT
cryostat volume	0.7 ton
TPC volume	0.25 ton
# channel	480
wire pitch	4 mm
electronics style	JFET (293K)
max. drift length	0.5m (330ms)
light collection	none

# 2. ArgoNeuT

First USA LArTPC neutrino experiment

- Small fiducial volume, but MINOS ND as muon range
- NuMI neutrino beamline (wideband 3 GeV beam with tail up to 20 GeV)

ArgoNeuT can reconstruct such event which is total impossible with other detector...

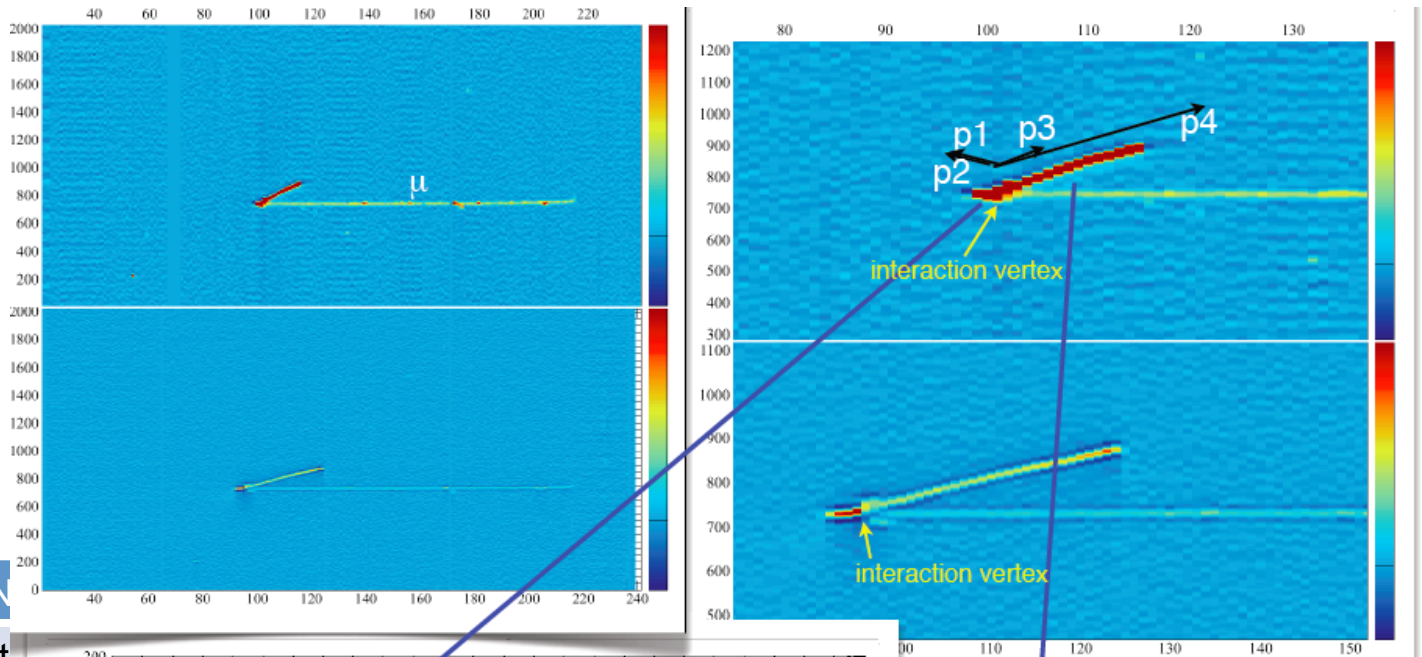

	ArgoNeuT
cryostat volume	0.7 t
TPC volume	0.25 t
# channel	480
wire pitch	4 mm
electronics style	JFET (2)
max. drift length	0.5m (3)
light collection	non

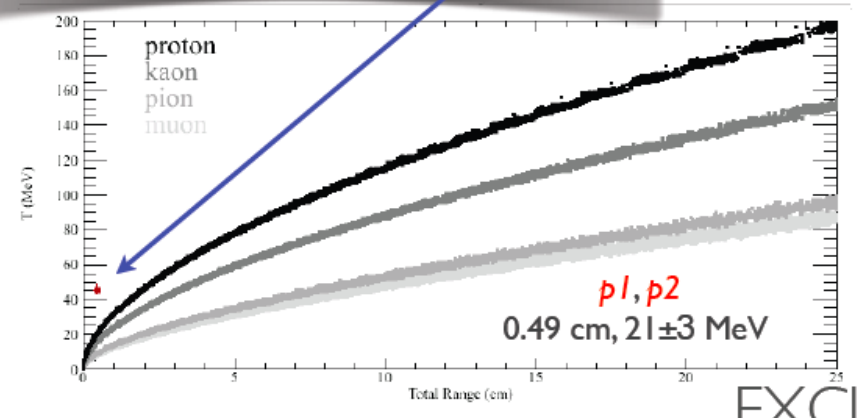

p4: 12 cm, 128±7 MeV  
 p3: 0.6 cm, 24±3 MeV

compatible with  
 1 μ 4p

DATA:

EXCLUSIVE TOPOLOGIES

# 1. USA LArTPC programs

100%  
Physics

Path to the large LArTPC in USA

50%R&D  
50%Physics

LArSoft

ArgoNeuT

Material test stand  
"LUKE" (Fermilab)

100%  
R&D

Yale TPC

Electronics test stand  
"Bo" (Fermilab)

LAPD

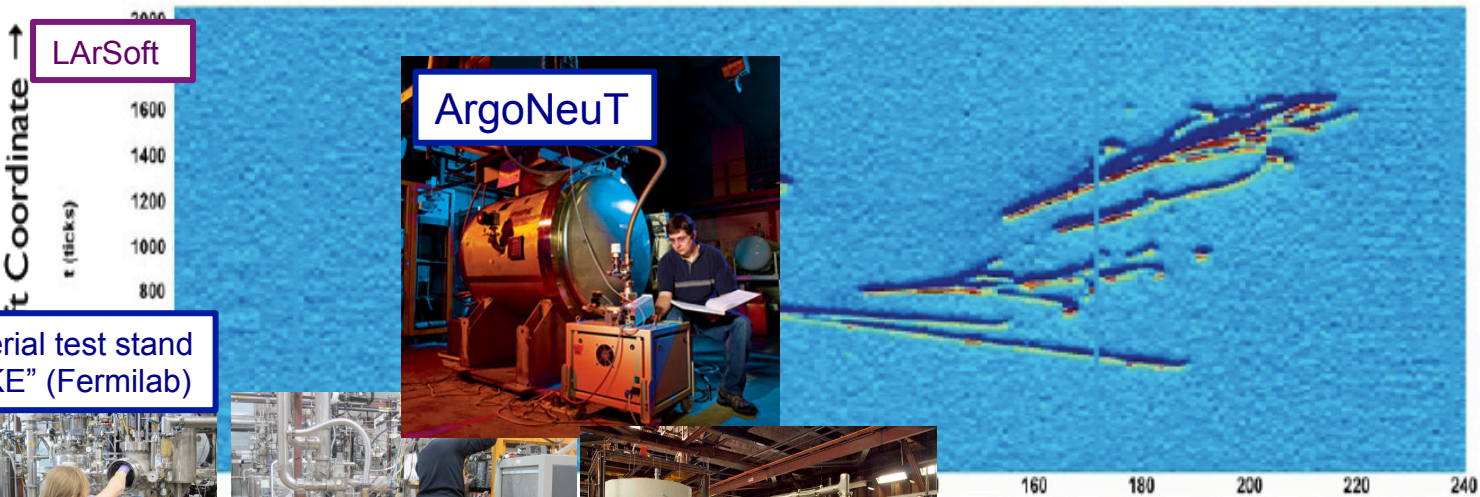

2007

2008

2010

2013

20??

## 2. LAPD (Liquid Argon Purity Demonstrator)

Large cryostat to achieve high purity without evacuation

- Purging room temperature argon gas to push out impurity
- It can achieve sub ppb purity after 1 week purging with recirculating argon gas (with filter)
- LAPD measure temperature, purity at various location
- Later, TPC is installed (long Bo)

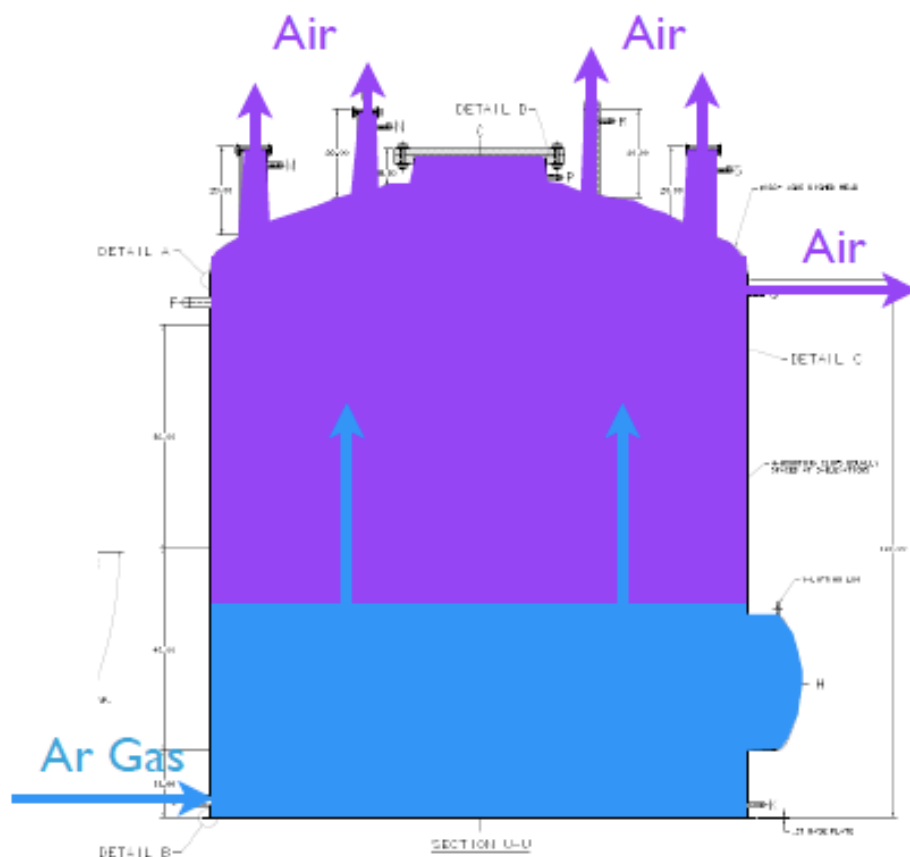

Liquid Argon Purity Demonstrator (LAPD)



## 2. LAPD (Liquid Argon Purity Demonstrator)

Large cryostat to achieve high purity without evacuation

- Purging room temperature argon gas to push out impurity
- It can achieve sub ppb purity after 1 week purging with recirculating argon gas (with filter)
- LAPD measure temperature, purity at various location
- Later, TPC is installed (long Bo)

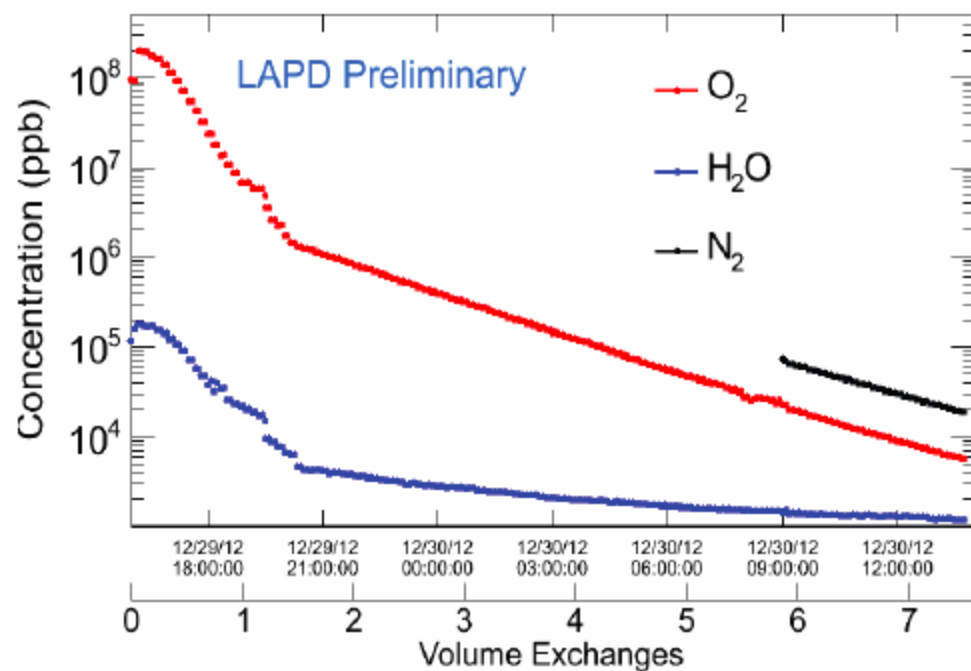

Liquid Argon Purity Demonstrator (LAPD)





# 1. USA LArTPC programs

100%  
Physics

Path to the large LArTPC in USA

50%R&D  
50%Physics

100%  
R&D

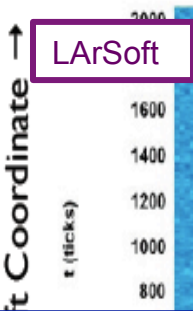

Material test stand  
"LUKE" (Fermilab)



Electronics test stand  
"Bo" (Fermilab)



## 2. MicroBooNE

### MiniBooNE low energy excess

- MiniBooNE cannot distinguish electron and photon

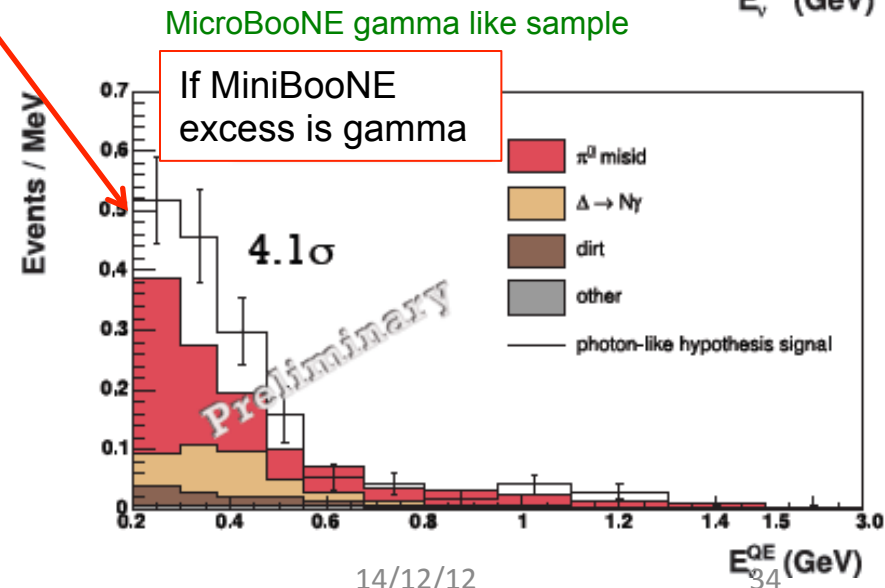
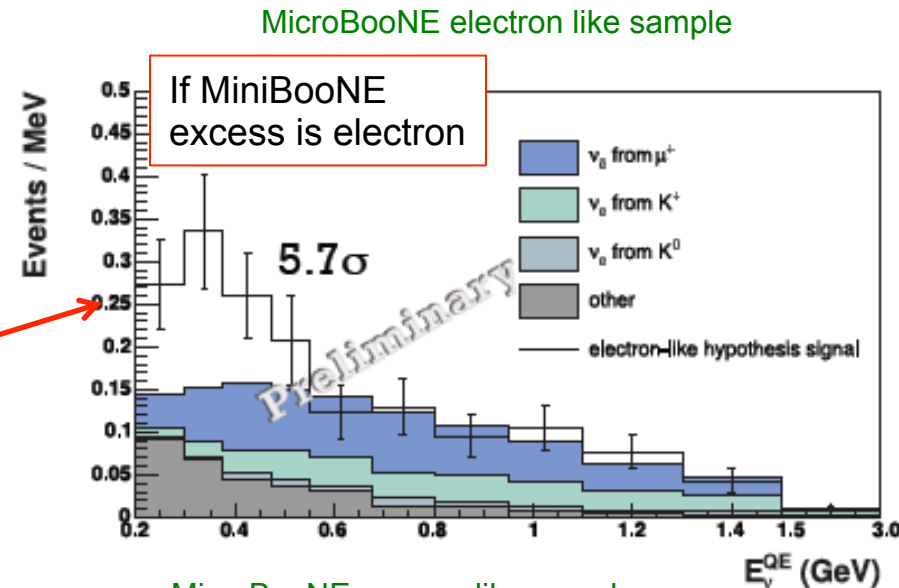
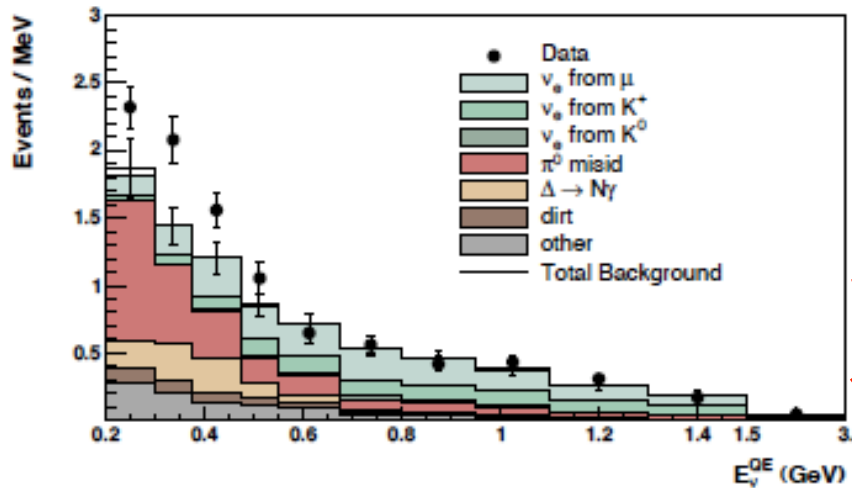

	ArgoNeuT	MicroBooNE
cryostat volume	0.7 ton	150 ton
TPC volume	0.25 ton	86 ton
max. drift length	0.5m (330ms)	2.5m (1.5ms)
electronics style	JFET (293K)	CMOS (87K)
# channel	480	~8,000
wire pitch	4 mm	3 mm
# wire plane	2	3
light collection	none	30 of 8" PMT

## 2. MicroBooNE

### Path to large LArTPC

- Roughly half size of ICARUS T300 (=half module of ICARUS T600)
- Booster Neutrino Beamline (wideband 800 MeV peak)
- All specs are improved from ArgoNeuT
  - more channels, denser wires, more planes
  - longer drift length (=need purer LAr)
  - cold electronics (closer FEB, lower CMOS noise)
  - photon collection system (later)
- Not vacuum insulated (foam insulated),  $<15\text{W/m}^2$
- Surface running

	ArgoNeuT	MicroBooNE
cryostat volume	0.7 ton	150 ton
TPC volume	0.25 ton	86 ton
max. drift length	0.5m (330ms)	2.5m (1.5ms)
electronics style	JFET (293K)	CMOS (87K)
# channel	480	~8,000
wire pitch	4 mm	3 mm
# wire plane	2	3
light collection	none	30 of 8" PMT



## 2. MicroBooNE

### Path to large LArTPC

- Roughly half size of ICARUS T300 (=half module of ICARUS T600)
- Booster Neutrino Beamline (wideband 800 MeV peak)
- All specs are improved from ArgoNeuT
  - more channels, denser wires, more planes
  - longer drift length (=need purer LAr)
  - cold electronics (closer FEB, lower CMOS noise)
  - photon collection system (later)
- Not vacuum insulated (foam insulated),  $<15\text{W/m}^2$
- Surface running

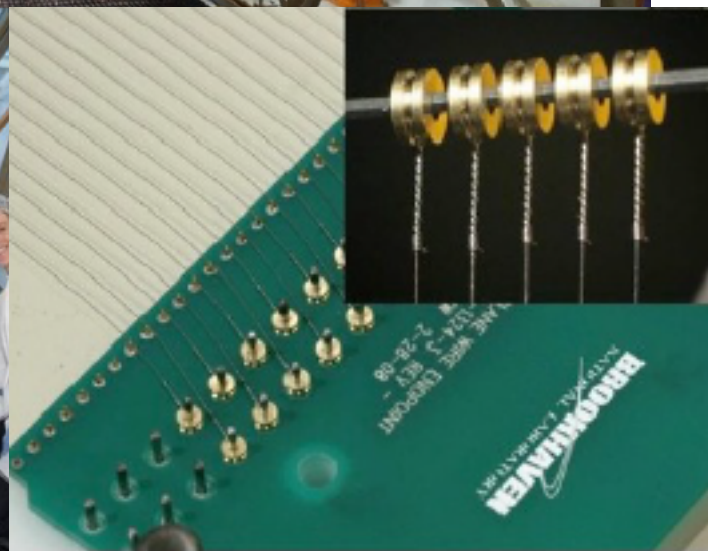
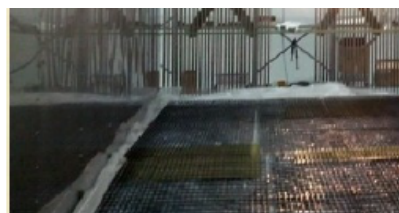

# 2. MicroBooNE

**Cathode**

**Anode**

**-128 kV**

**$E = 500 \text{ V/cm}$**

**HV Feedthrough**

**Field Cage**

**3 wire planes (vertical, +/- 60°)**  
**3mm spacing**

**Tubes are connected with 250MΩ resistors for field uniformity**

**BROOKHAVEN**  
T PLANE WIRE CARRIER - BOTTOM  
6-024-3 REV B  
LAF 9-16-11

The image shows a large detector structure with a central field cage. A cathode is on the left and an anode is on the right. A voltage of -128 kV is applied to the cathode, creating an electric field of 500 V/cm. The field cage consists of three wire planes (vertical, +/- 60°) with 3mm spacing. The tubes are connected with 250MΩ resistors for field uniformity. A detailed view of the HV feedthrough and a close-up of the wire carrier are also shown.

# 1. USA LArTPC programs

100%  
Physics

Path to the large LArTPC in USA

50%R&D  
50%Physics

100%  
R&D

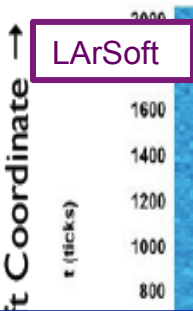

2007

2008

2010

2013

20??

## 2. LBNE35ton prototype

Membrane cryostat

- Only viable technology of large cryostat

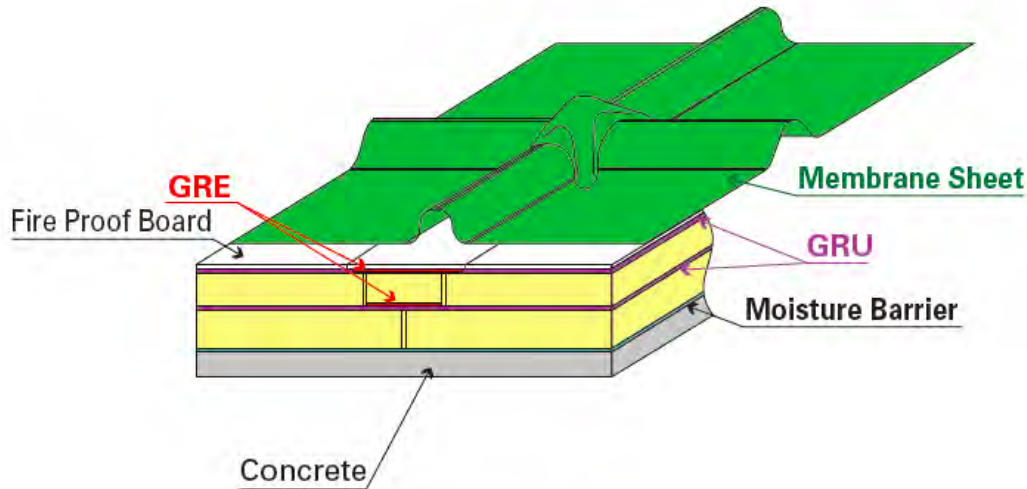

GRE: Glass Cloth Reinforced Epoxy

GRU: Glass Cloth Reinforced urethane

worker



216,000m<sup>3</sup> LNG tanker (~300 kt of LAr)



The LNGC "Tembek", one of the thirty-one 216,000 m<sup>3</sup> LNG carriers ordered by Nakilat and delivered in 2008

## 2. LBNE35ton prototype





## 2. LBNE35ton prototype



# 2. LBNE35ton prototype



## 2. LBNE35ton prototype

CERN  
COURIER7–10 April 2014  
Glyndwr University, St Asaph, UK
[Latest Issue](#) | [Archive](#) | [Jobs](#) | [Links](#) | [Buyer's guide](#) | [White papers](#) | [Events](#) | [Contact us](#)

 Search  

## REGISTER NOW

**Register** as a member of [cerncourier.com](http://cerncourier.com) and get full access to all features of the site. Registration is free.

## LATEST CERN COURIER ARTICLES

- ▶ New recipes for stopping neutrons
- ▶ Sommaire en français
- ▶ First-photon imaging
- ▶ Volcanic lightning
- ▶ 3D graphene from sugar

## SHARE THIS

E-mail to a friend

StumbleUpon

Twitter

Facebook

CiteUlike

SHARE ...

## RELATED PRODUCTS

**Portable Thermal Imaging Kits**

FLIR Advanced Thermal Solutions  
Group (FLIR ATS)  
Mar 3, 2014

## CERN COURIER

Feb 24, 2014

## LBNE prototype cryostat exceeds goals

Scientists and engineers working on the design of the particle detector for the Long-Baseline Neutrino Experiment (LBNE) celebrated a major success in January. They showed that very large cryostats for liquid-argon-based neutrino detectors can be built using



The LBNE prototype cryostat

industry-standard technology normally employed for the storage of liquefied natural gas. The 35-tonne prototype system satisfies LBNE's stringent purity requirement on oxygen contamination in argon of less than 200 parts per trillion (ppt) – a level that the team could maintain stably.

The purity of liquid argon is crucial for the proposed LBNE time-projection chamber (TPC), which will feature wire planes that collect electrons from an approximately 3.5 m drift region. Oxygen and other electronegative impurities in the liquid can absorb ionization electrons created by charged particles emerging from neutrino interactions and prevent them from reaching the TPC's signal wires.

The test results were the outcome of the first phase of operating the LBNE prototype cryostat, which was built at Fermilab and features a membrane designed and supplied by the IHI Corporation of Japan. As part of the test, engineers cooled the system and filled the cryostat with liquid argon without prior evacuation. On 20 December, during a marathon 36 hour session, they cooled the membrane cryostat slowly and smoothly to 110 K, at which point they commenced the transfer of some 20,000 litres of liquid argon, maintained at about 89 K, from Fermilab's Liquid Argon Purity Demonstrator to the 25 tonne cryostat

## DIGITAL EDITION

CERN Courier is now available as a regular digital edition. [Click here](#) to read the digital edition.

## KEY SUPPLIERS

[More companies ▶](#)

## FEATURED COMPANIES

# 1. USA LArTPC programs

100% Physics

Path to the large LArTPC in USA

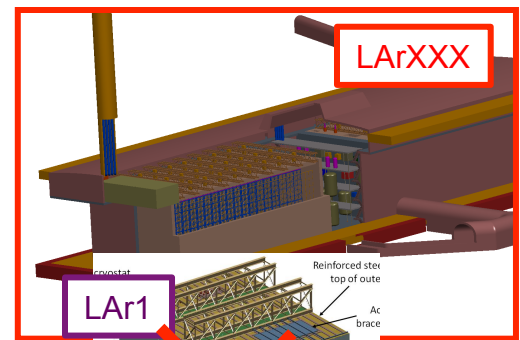

MicroBooNE



Captain

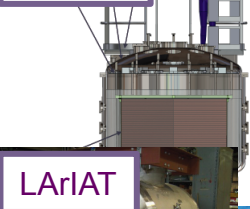

LAr1-ND

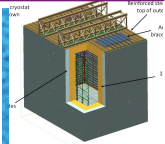

LArIAT



LBNE 35ton

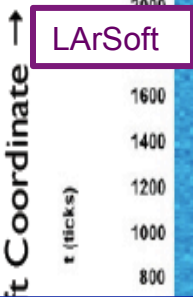

ArgoNeuT



50% R&D  
50% Physics

Material test stand "LUKE" (Fermilab)



Electronics test stand "Bo" (Fermilab)

100% R&D

Yale TPC

LAPD

2007

2008

2010

2013

20??

## 2. LBNE

### Future large LArTPC

- Now LAr20 (2 modules, 10 kton each)
- Light guide idea for photon detection (later)

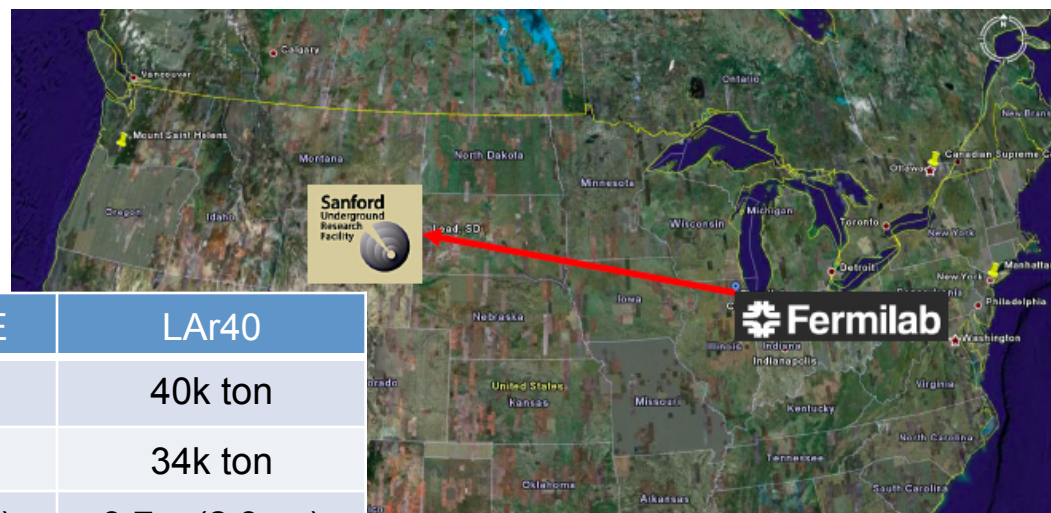

	ArgoNeuT	MicroBooNE	LAr40
cryostat volume	0.7 ton	150 ton	40k ton
TPC volume	0.25 ton	86 ton	34k ton
max. drift length	0.5m (330ms)	2.5m (1.5ms)	3.7m (2.3ms)
electronics style	JFET (293K)	CMOS (87K)	CMOS (87K)
# channel	480	~8,000	~266,000
wire pitch	4 mm	3 mm	5 mm
# wire plane	2	3	3
light collection	none	30 of 8" PMT	light guide

# 2. LBNE

## Future large LArTPC

- Now LAr20 (2 modules, 10 kton each)
- Light guide idea for photon detection (later)
- Strongly recommended by P5
- International collaboration is necessary

	ArgoNeuT	MicroBooNE
cryostat volume	0.7 ton	150 ton
TPC volume	0.25 ton	86 ton
max. drift length	0.5m (330ms)	2.5m (1.5m)
electronics style	JFET (293K)	CMOS (800K)
# channel	480	~8,000
wire pitch	4 mm	3 mm
# wire plane	2	3
light collection	none	30 of 8" F

### Table 1 Summary of Scenarios

Project/Activity	Scenarios			Science Drivers					Technique (Frontier)
	Scenario A	Scenario B	Scenario C	Higgs	Neutrinos	Dark Matter	Cosm.-Accel.	The Unknown	
<b>Large Projects</b>									
Muon program: Mu2e, Muon g-2	Y, <small>Mu2e small reprofile needed</small>	Y	Y						✓ I
HL-LHC	Y	Y	Y	✓		✓			✓ E
LBNF + PIP-II	Y, <small>LBNF components delayed relative to Scenario B.</small>	Y	Y, enhanced		✓				✓ I,C
ILC	R&D only	R&D, <small>possibly small, hardware contributions. See text.</small>	Y	✓		✓			✓ E
NuSTORM	N	N	N		✓				I
RADAR	N	N	N		✓				I
<b>Medium Projects</b>									
LSST	Y	Y	Y		✓		✓		C
DM G2	Y	Y	Y			✓			C
Small Projects Portfolio	Y	Y	Y		✓	✓	✓	✓	All
Accelerator R&D and Test Facilities	Y, reduced	Y, <small>some reductions with redirection to PIP-II development</small>	Y, enhanced	✓	✓	✓		✓	E,I
CMB-S4	Y	Y	Y		✓		✓		C
DM G3	Y, reduced	Y	Y			✓			C
PINGU	Further development of concept encouraged				✓	✓			C
ORKA	N	N	N						✓ I
MAP	N	N	N	✓	✓	✓		✓	E,I
CHIPS	N	N	N		✓				I
LAr1	N	N	N		✓				I
<b>Additional Small Projects (beyond the Small Projects Portfolio above)</b>									
DESI	N	Y	Y		✓		✓		C
Short Baseline Neutrino Portfolio	Y	Y	Y		✓				I

TABLE 1 Summary of Scenarios A, B, and C. Each major project considered by P5 is shown, grouped by project size and listed in time order based on year of peak construction. Project sizes are: Large (>\$200M), Medium (\$50M-\$200M), and Small (<\$50M). The science Drivers primarily addressed by each project are also indicated, along with the Frontier technique area (E-Energy, I-Intensity, C-Cosmic) defined in the 2008 P5 report.

## NEWS SCIENCE &amp; ENVIRONMENT

[Home](#) [World](#) [UK](#) [England](#) [N. Ireland](#) [Scotland](#) [Wales](#) [Business](#) [Politics](#) [Health](#) [Education](#) [Sci/Environment](#) [Technology](#) [Entertainment & Arts](#)

## Neutrino beam 'major physics experiment'

1 hour ago

The UK will be part of what is being described as one of the biggest physics experiments ever built, in an effort to learn more about the creation of the universe.

Researchers will fire a beam of particles called neutrinos through 1,300km (800 miles) of rock - from their lab near Chicago to a location in South Dakota.

The UK's role in the \$1.5bn (£1bn) project will be to help to build a giant neutrino detector, likely to be about 12m (39ft) across.

Studying how the particles change as they travel will give a deeper

### Related video / audio



Dark matter hunt in US gold mine  
30 May 2012

### Most watched



Somerset floods 'up to door knocker'  
1 hour ago



Aerial video shows submerged homes  
4 hours ago



William and Harry shift sandbags  
8 hours ago



'Streets awash with sewage' in Surrey  
59 minutes ago



Chertsey 'sausage' angers residents  
14 February 2014

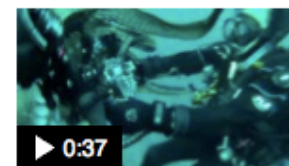

Octopus wrestles with US cameraman  
14 February 2014

Show More

## 2. LBNE

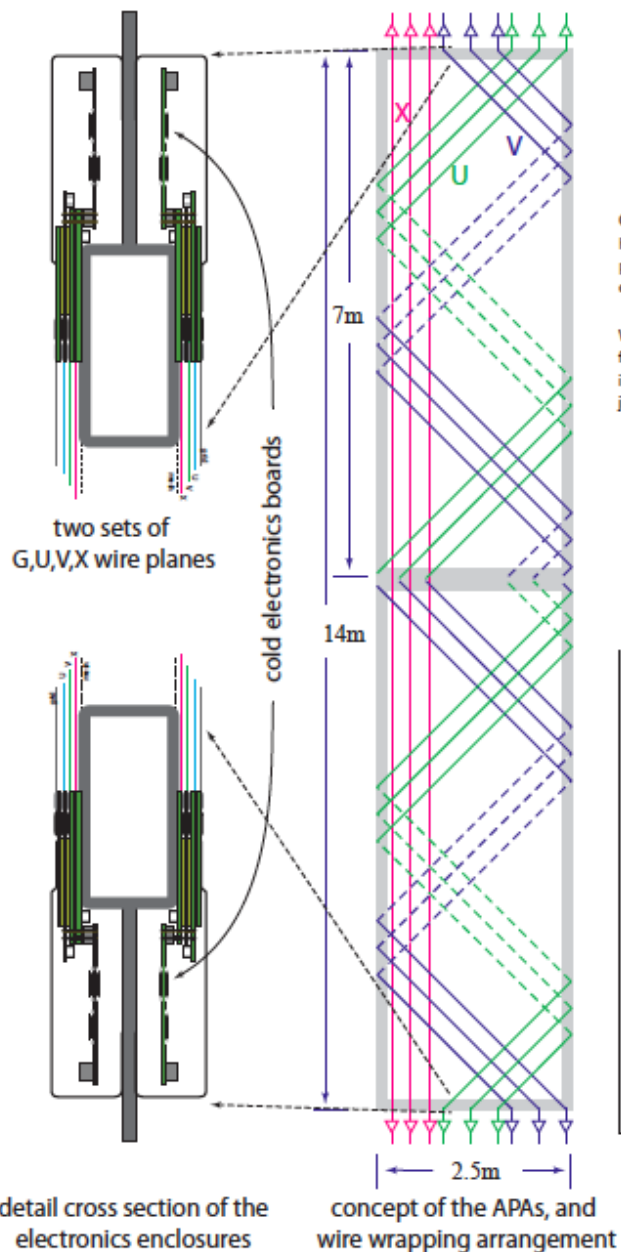

installation of APAs inside the cryostat

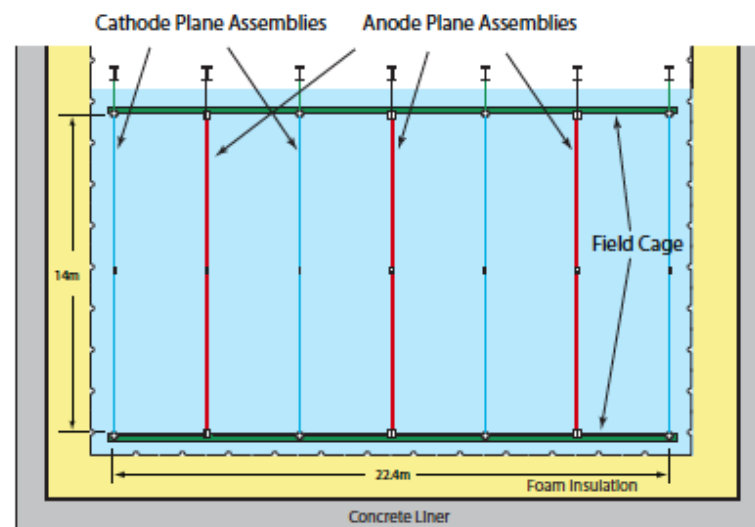
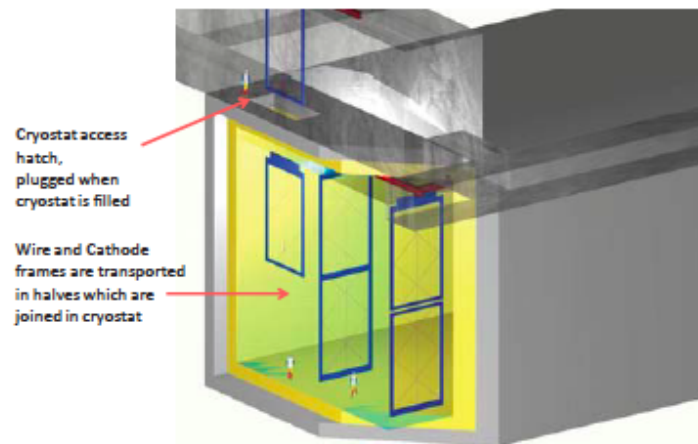

cross section view of the TPC components inside the cryostat



1. Introduction
2. US LArTPC programs
- 3. LAr photon detection R&D**
4. Challenge of LArTPC technology
5. Conclusion

### 3. Scintillation light from argon

#### Noble gas comparison

- lower boiling point is easier to handle
- higher density has more energy deposit
- longer wavelength is easier to detect
- Xe>Kr>Ar>Ne>He but Xe and Kr are expensive

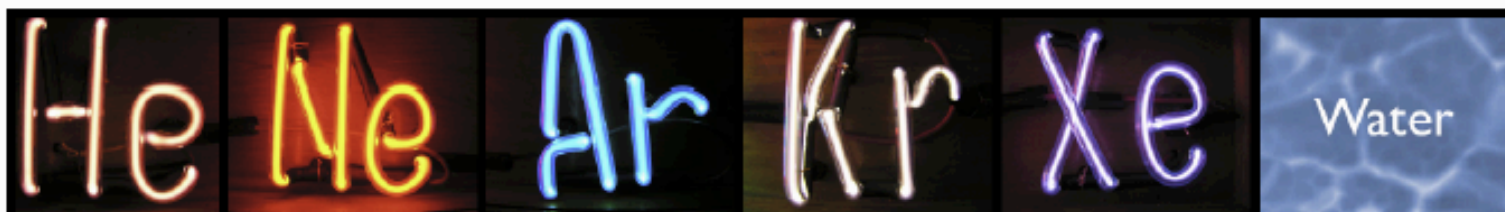

	He	Ne	Ar	Kr	Xe	Water
Boiling Point [K] @ 1atm	4.2	27.1	87.3	120.0	165.0	373
Density [g/cm <sup>3</sup> ]	0.125	1.2	1.4	2.4	3.0	1
Radiation Length [cm]	755.2	24.0	14.0	4.9	2.8	36.1
Scintillation [ $\gamma$ /MeV]	19,000	30,000	40,000	25,000	42,000	
dE/dx [MeV/cm]	0.24	1.4	2.1	3.0	3.8	1.9
Scintillation $\lambda$ [nm]	80	78	128	150	175	

### 3. Scintillation light from argon

#### Argon as gas scintillator

Organic scintillator (PPO, POPOP, PBD, etc)

- S0-S1 excitation of  $\pi$ -electron

Inorganic scintillator (NaI(Tl), etc)

- Crystal with impurity

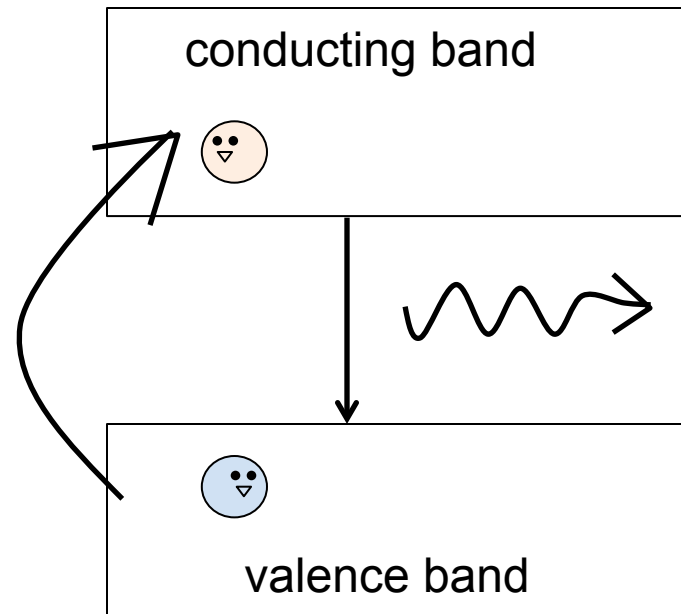
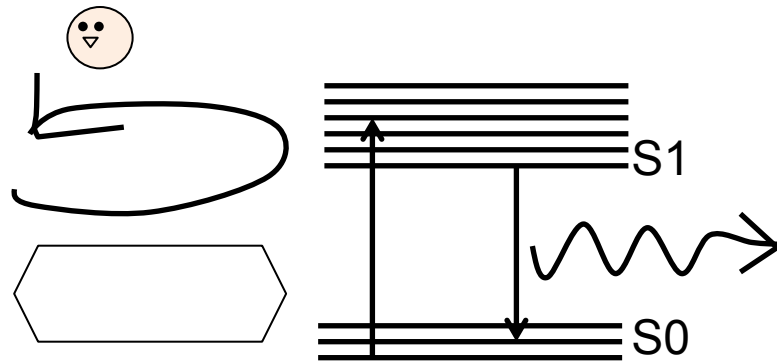

### 3. Scintillation light from argon

#### Argon as gas scintillator

- 2 excitation path, singlet (spin 0) and triplet (spin 1)
- prompt signal can be used for trigger
- delayed signal is sensitive to impurity (nitrogen)
- both vacuum UV (128nm)

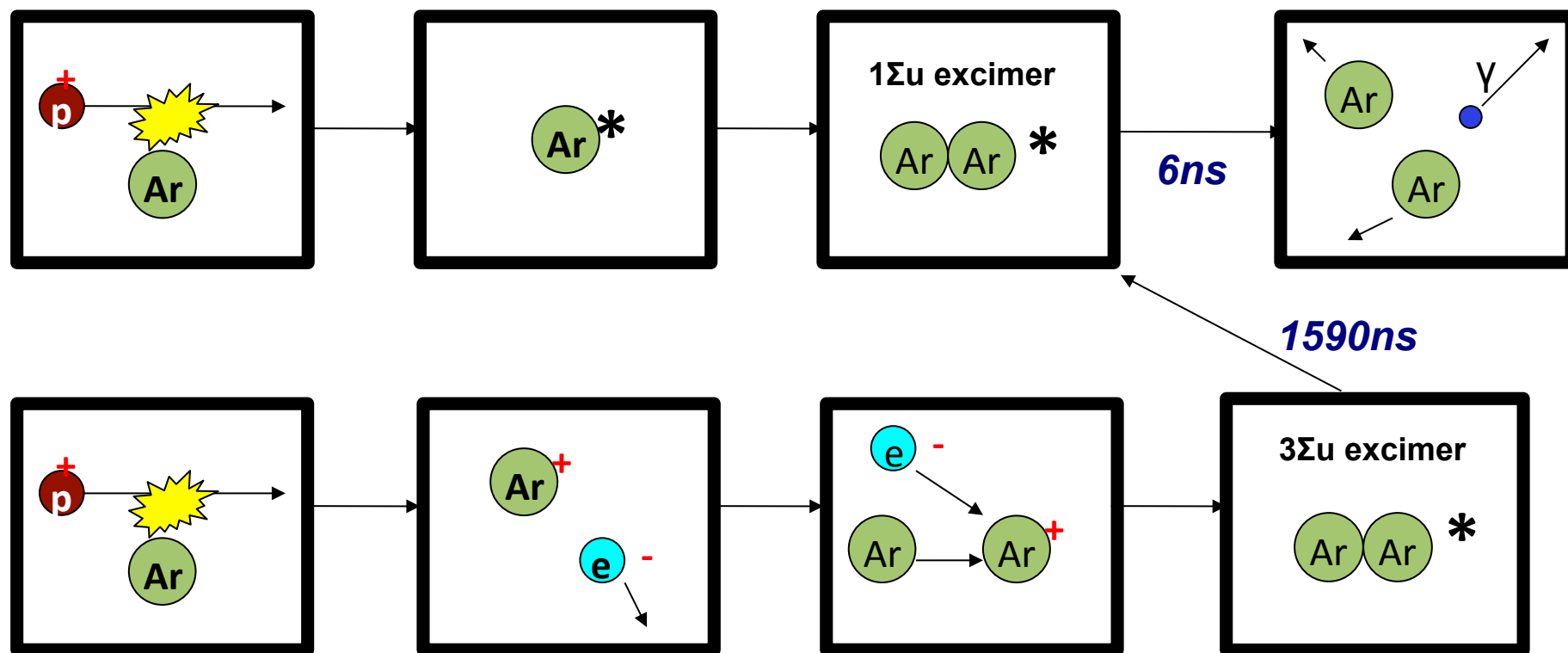

### 3. Scintillation light from argon

#### Argon as gas scintillator

- 2 excitation path, singlet (spin 0) and triplet (spin 1)
- prompt signal can be used for trigger
- delayed signal is sensitive to impurity (nitrogen)
- both vacuum UV (128nm)

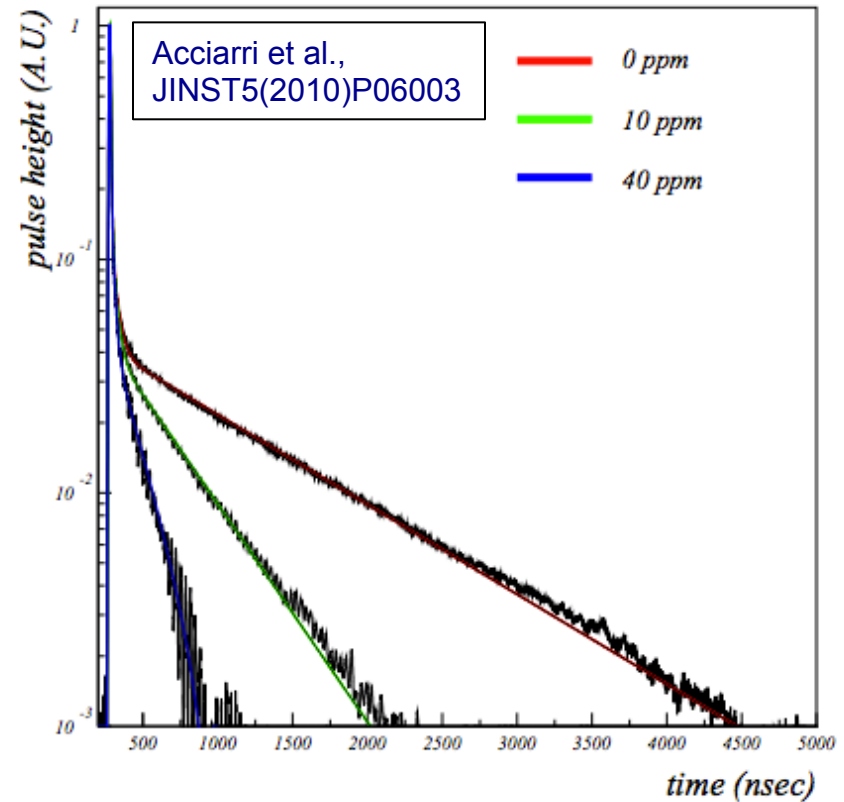
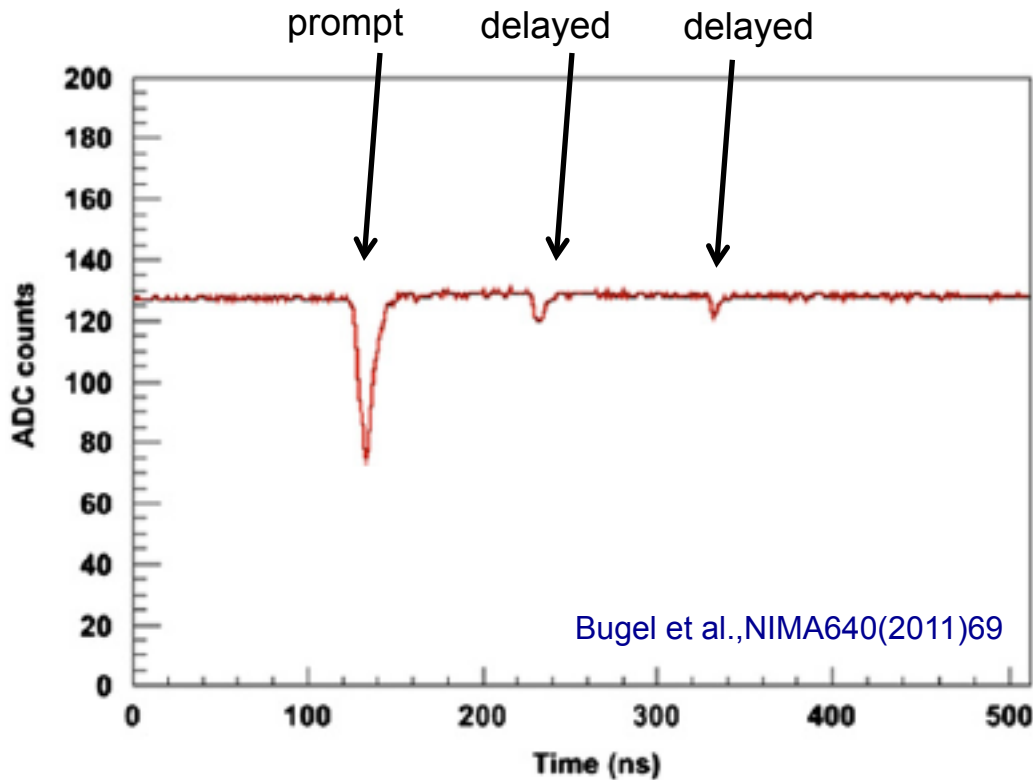

# 3. Scintillation light from argon

TPB (tetraphenyl butadiene)

- convert 128nm to blue (efficiency > 100%?!)
- degrade by UV light (possibly by humidity, too)

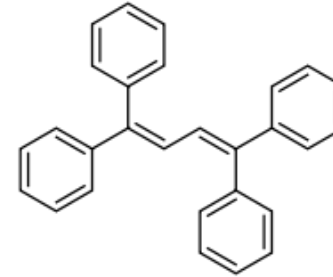

TPB plate performance degradation

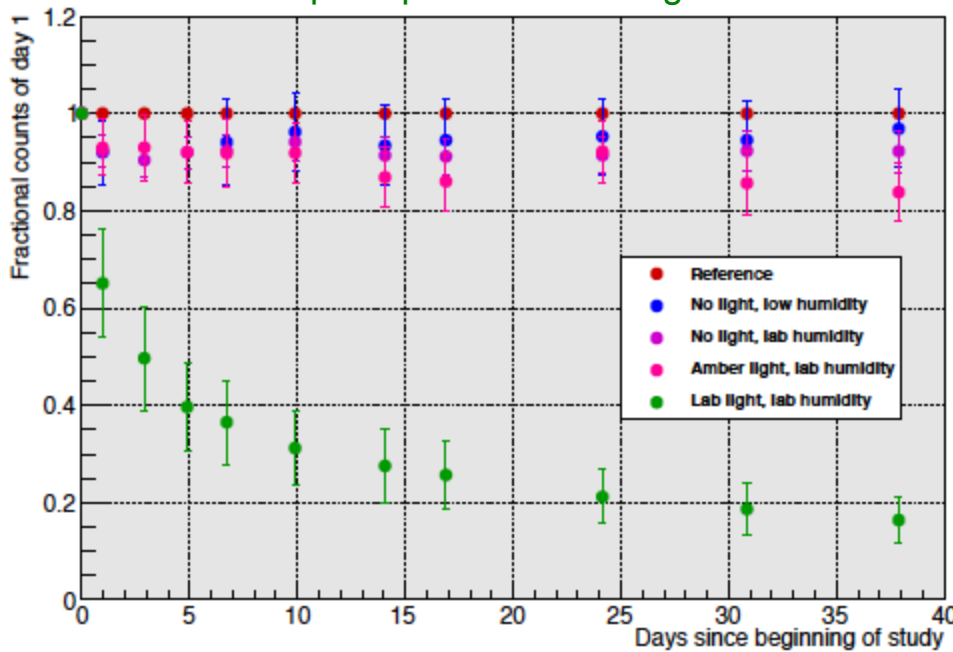

Chiu et al., JINST7(2012)P07007

Benzophenone production

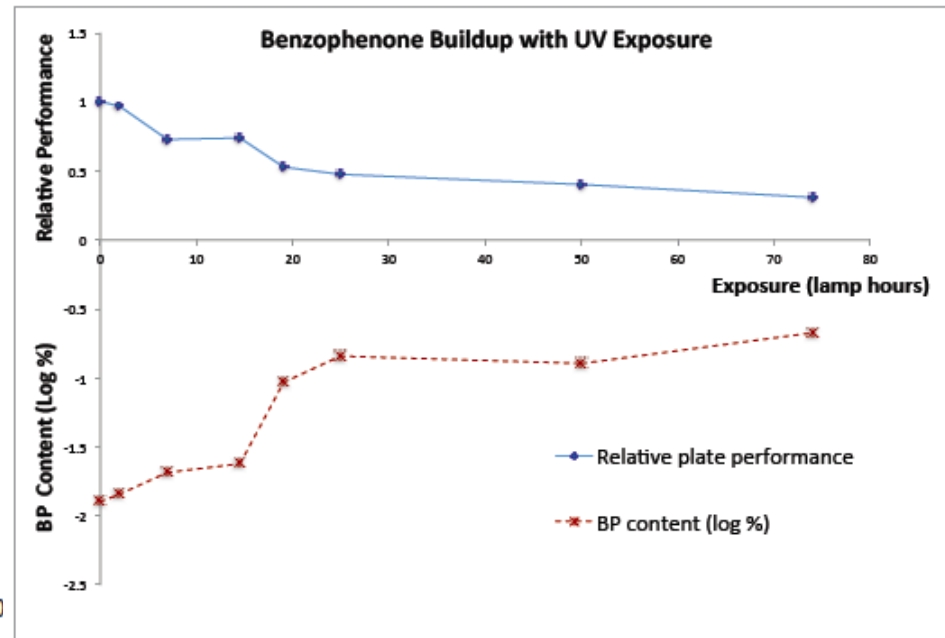

Jones et al., JINST8(2013)P01013

### 3. Scintillation light from argon

#### TPB plate idea

- deposit TPB-polystyrene mixture on acrylic plate (TPB plate)
- equip TPB in front of PMT

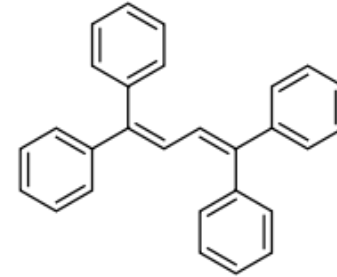

Mechanical model of  
MicroBooNE PMT

TPB plate sample

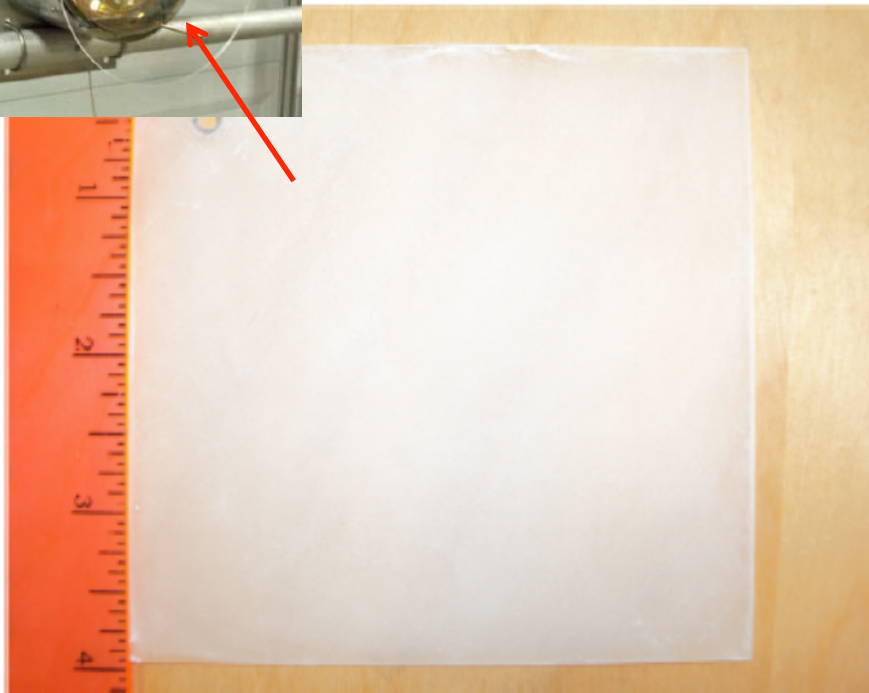

Lab6 scintillation building

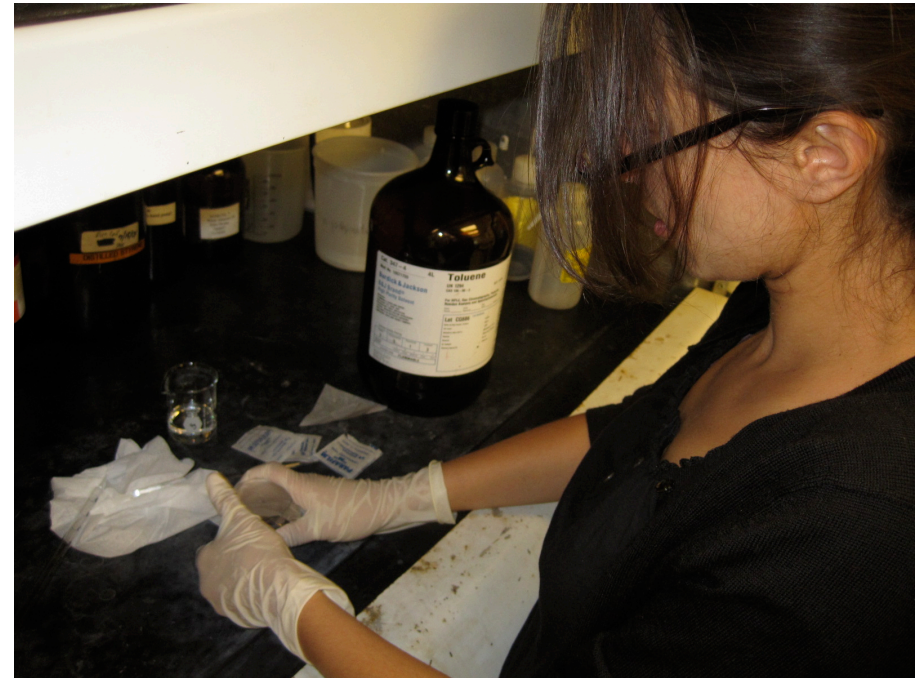

### 3. Scintillation light from argon

#### TPB plate idea

- deposit TPB-polystyrene mixture on acrylic plate (TPB plate)
  - equip TPB in front of PMT
  - performance of TPB plate is measured by vacuum spectrometer.
- Comparing with vacuum evaporated plate, it is ~OK

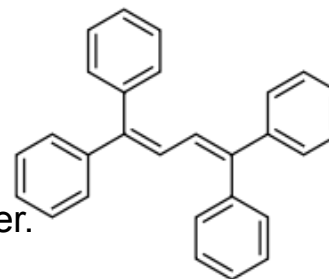

#### Deuterium lamp spectrum

#### Fermilab vacuum spectrometer

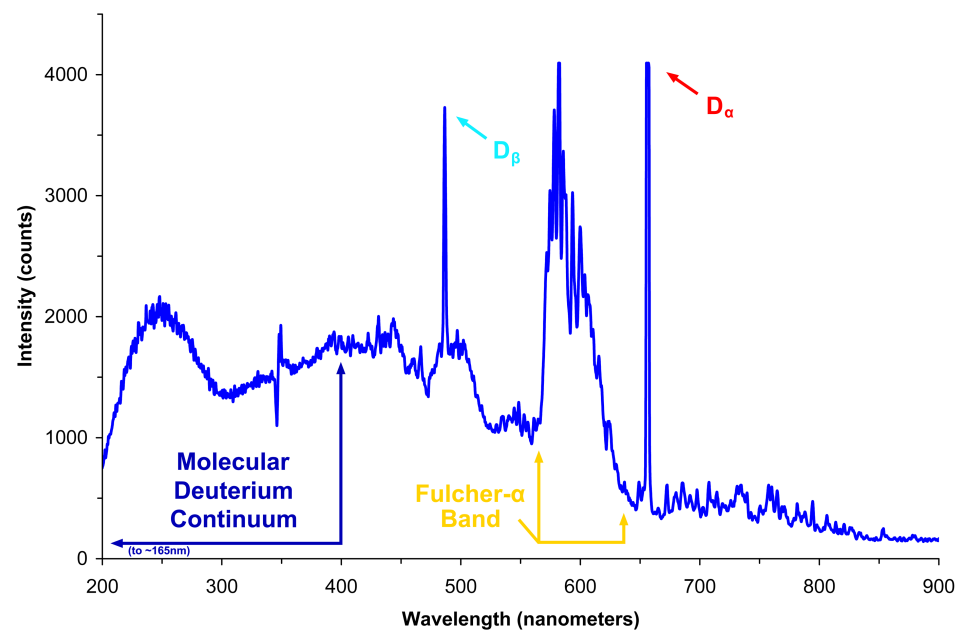
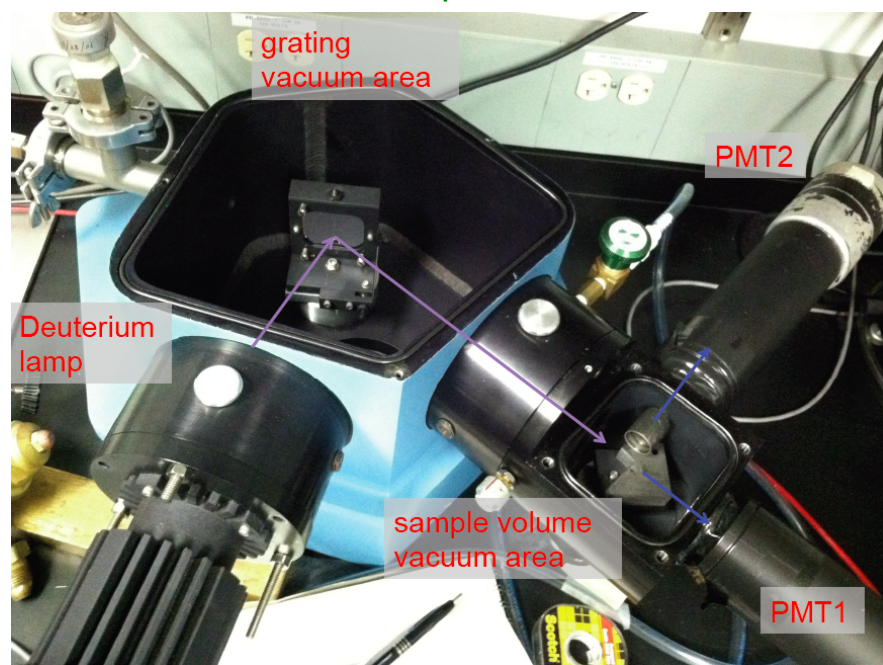



### 3. Scintillation light from argon

#### TPB plate idea

- deposit TPB-polystyrene mixture on acrylic plate (TPB plate)
  - equip TPB in front of PMT
  - performance of TPB plate is measured by vacuum spectrometer.
- Comparing with vacuum evaporated plate, it is ~OK

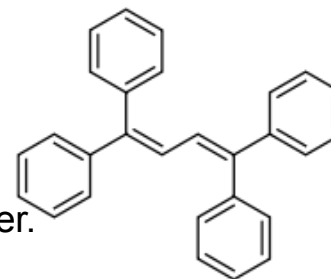

#### TPB plate performance

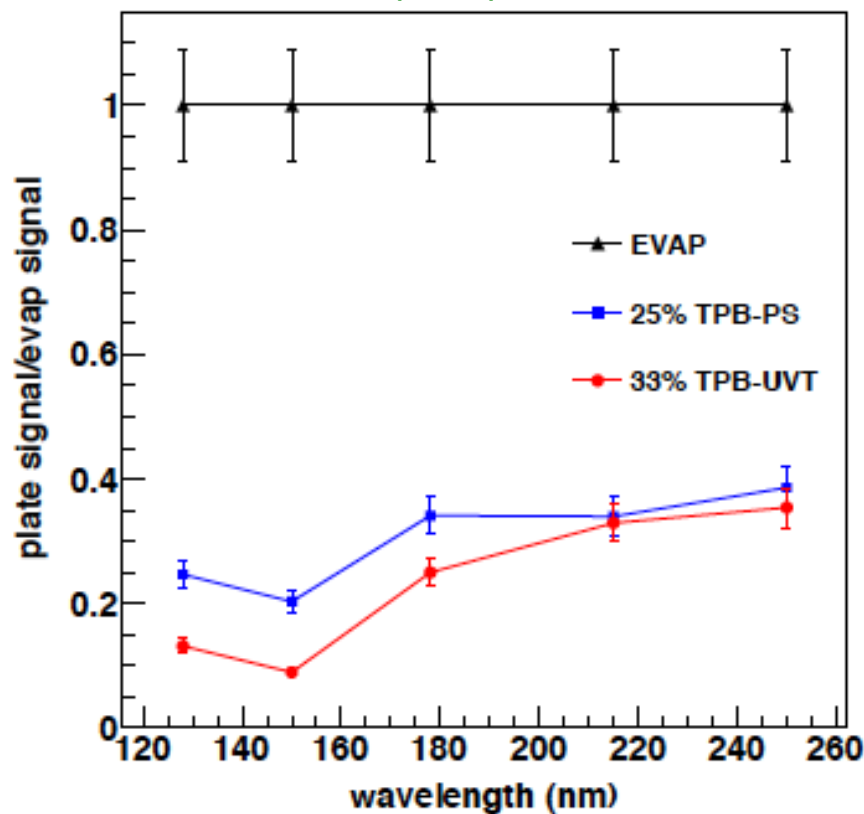
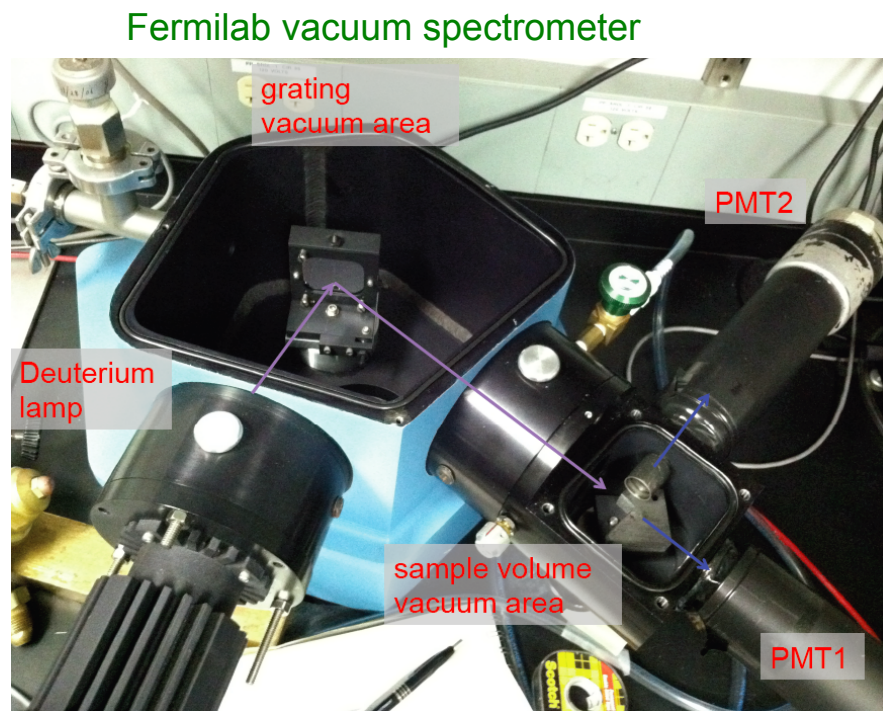

### 3. Scintillation light from argon

#### Impurity measurement

- $O_2$  and  $N_2$  are known impurity to reduce scintillation output
- Nitrogen is not controlled in LArTPC experiment (oxygen is <ppb to make TPC works)
- Nitrogen injection line and monitor is installed in Bo cryostat system

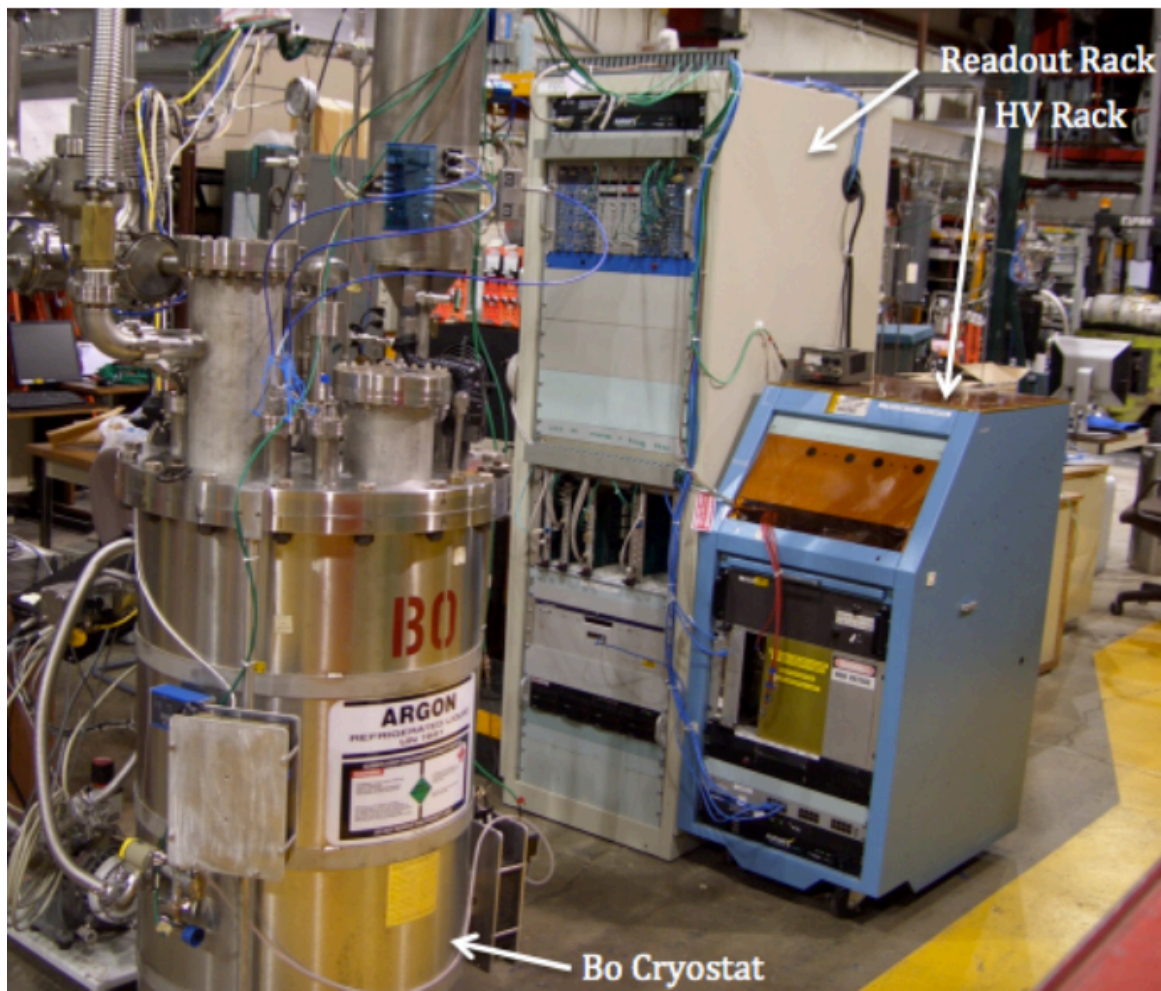

# 3. Scintillation light from argon

## Impurity measurement

- O<sub>2</sub> and N<sub>2</sub> are known impurity to reduce scintillation output
- Nitrogen is not controlled in LArTPC experiment (oxygen is <ppb to make TPC works)
- Nitrogen injection line and monitor is installed in Bo cryostat system

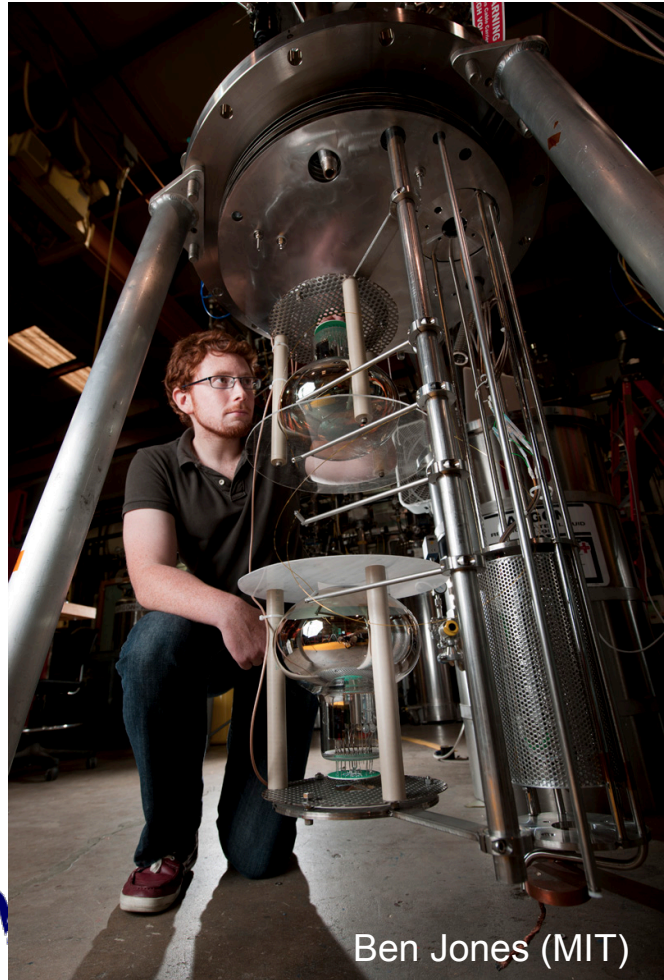

Ben Jones (MIT)

University of London

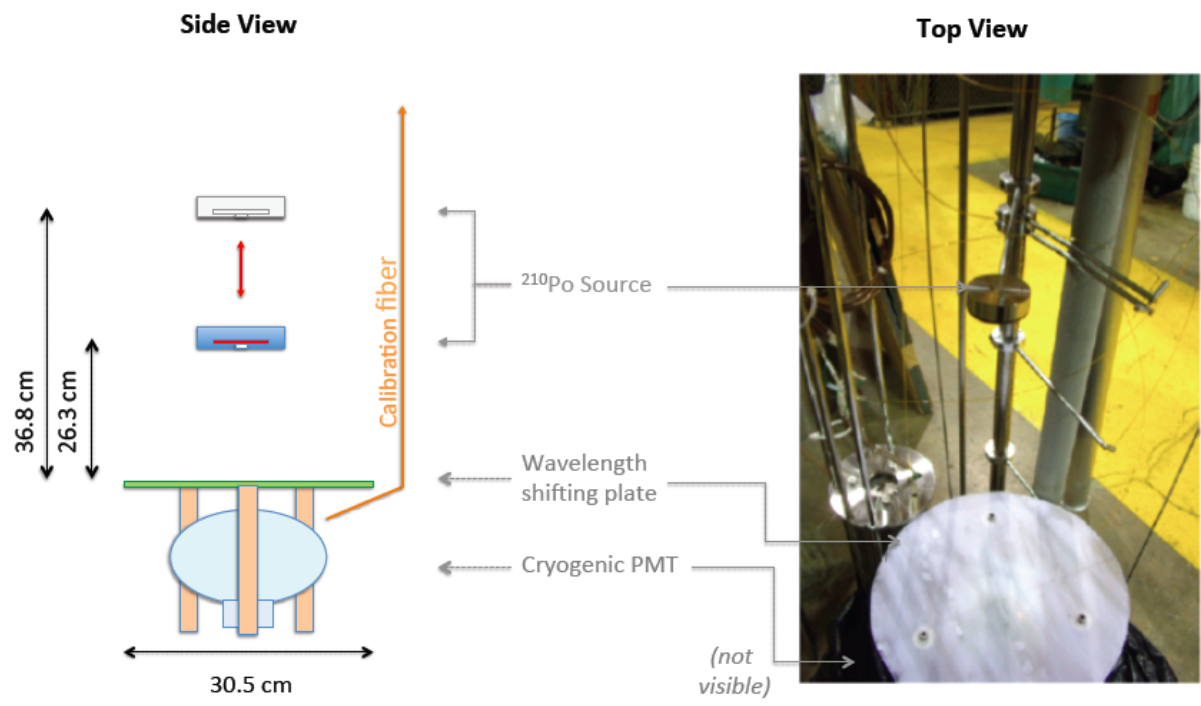

Tepei Katori

14/12/12

### 3. Scintillation light from argon

#### Impurity measurement

- $O_2$  and  $N_2$  are known impurity to reduce scintillation output
- Nitrogen is not controlled in LArTPC experiment (oxygen is <ppb to make TPC works)
- Nitrogen injection line and monitor is installed in Bo cryostat system
- LAr with “typical”  $N_2$  impurity has negligible effect on attenuation

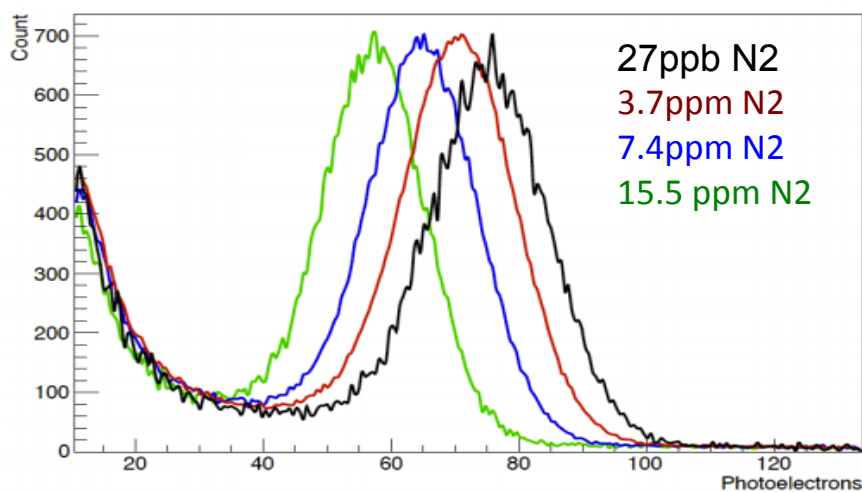

Light output from  $^{210}\text{Po}$

Argon Specification	Concentration of $N_2$	Absorption Length
Measured $N_2$ concentration of clean argon for this study	37 ppb	$1790 \pm 160$ m
AirGas research (grade 6) argon [25]	1 ppm	$66 \pm 6$ m
MicroBooNE cryogenic specification	2 ppm	$30 \pm 3$ m
Start of liquid recirculation phase of Liquid Argon Purity Demonstrator, Run 2 [26, 27]	8 ppm	$8.2 \pm 0.7$ m
AirGas industrial (grade 4) argon [25]	100 ppm	$0.65 \pm 0.06$ m

### 3. Scintillation light from argon

#### Cryogenic PMT

- bi-alkali photo-cathode stops working at  $\sim 150\text{K}$
- Pt-coating to save electron mobility (1<sup>st</sup> generation cryogenic PMT)
  - slight loss of quantum efficiency
- super bi-alkali works in cold (2<sup>nd</sup> generation cryogenic PMT)
- base circuit should avoid temperature dependent components
- heat deposit  $\sim 0.5\text{W}/\text{base}$

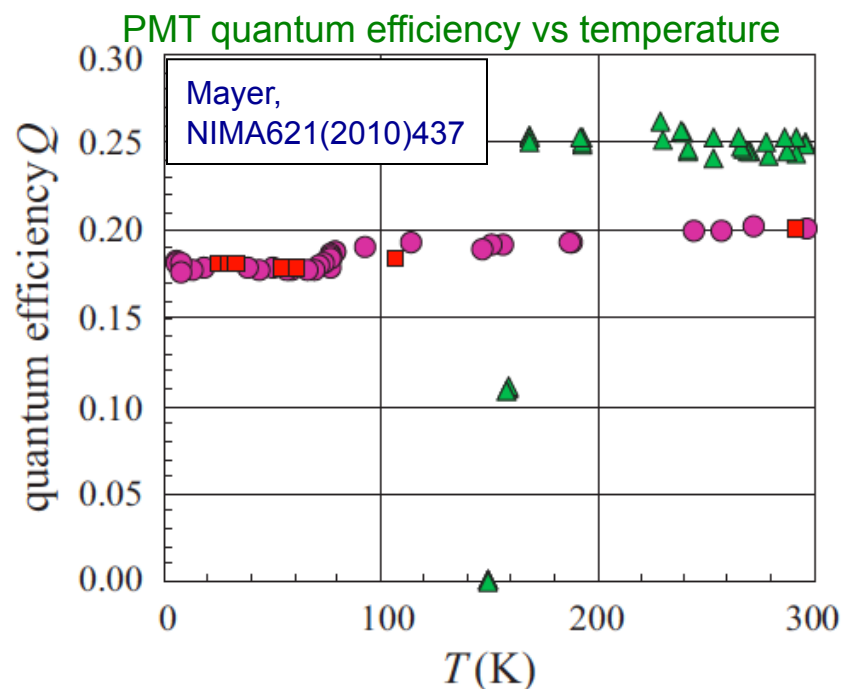

MicroBooNE PMT base

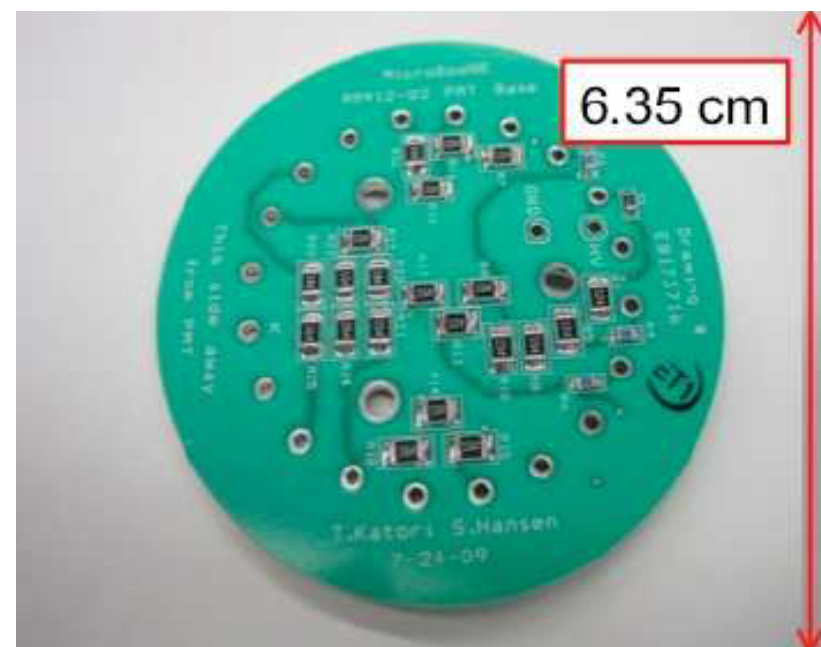

### 3. MicroBooNE PMT test stand

Open Dewar based PMT test stand

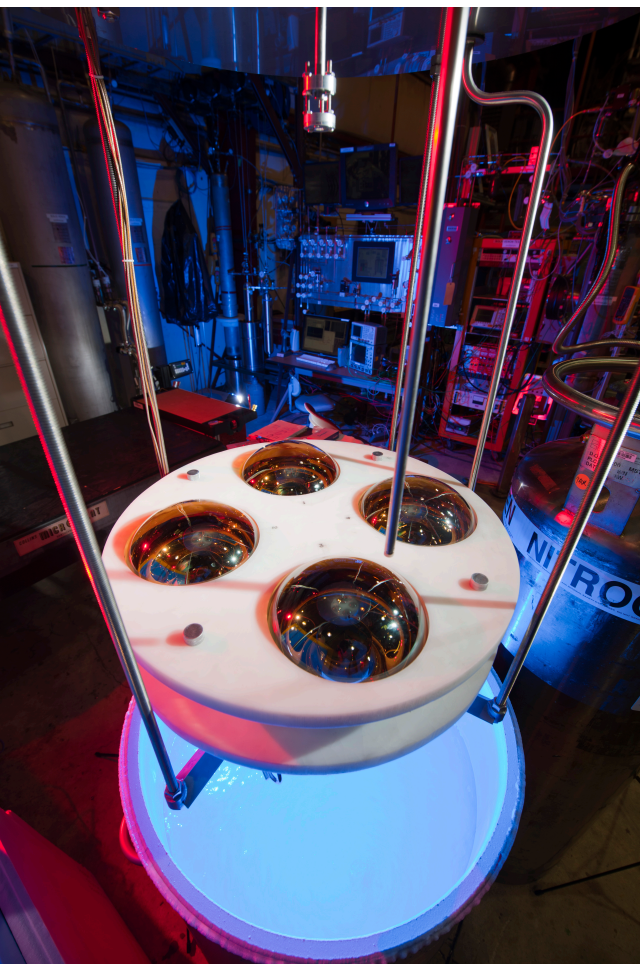

### PMT TEST STAND

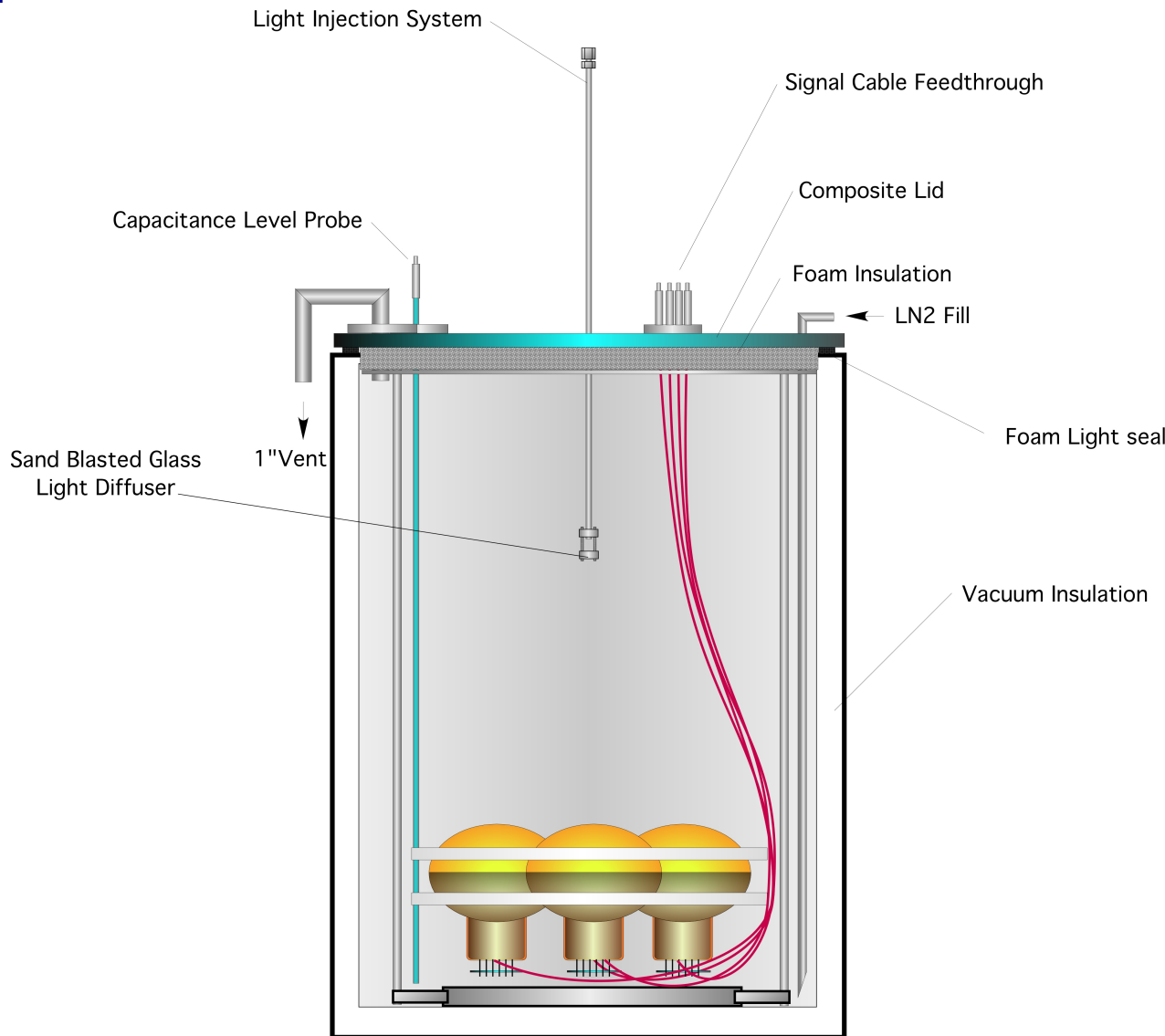

### 3. MicroBooNE PMT test stand

#### Open Dewar based PMT test stand

- All structures are attached on glass fiber lid
- there are 5 penetrations
  - LN2 injection
  - gas vent
  - level sensor
  - cable feed-through
  - light injection system
- In room temperature, PMTs sit on Delrin bottom fixture
- In LN2, PMTs float and fit in Delrin upper fixture
- There is a weight at the bottom of the structure

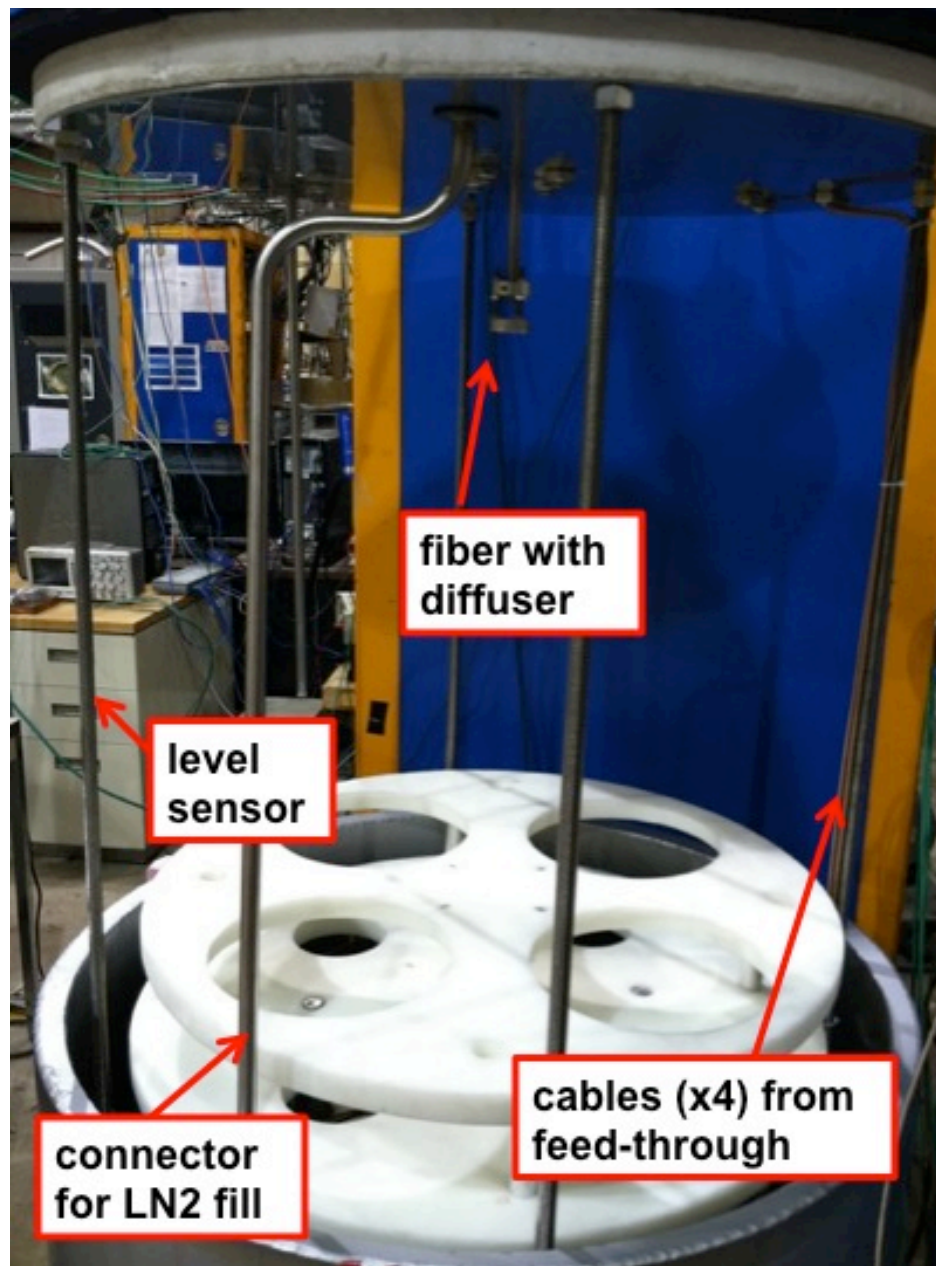
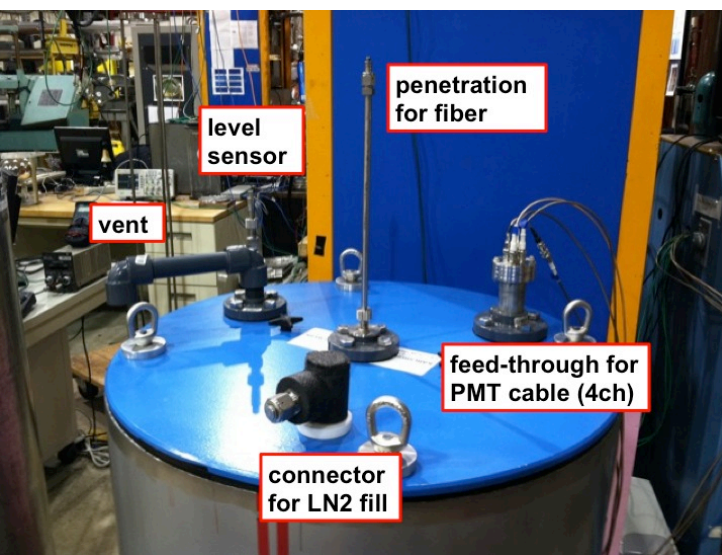

## 3. MicroBooNE PMT test stand

### Open Dewar based PMT test stand

#### Purpose

- All PMTs need to be operated in cryogenic temperature before the experiment
- Verify spec gain and dark current in cryogenic condition
- Gain experiences of cryogenic PMT operation
- Study basic features (how long do you need to cool down, etc)

No need to be pressurized vessel (expensive, safety issue)

#### Large open Dewar with modification

- commercial open Dewar, 346L (70cmx90cm inner diameter and height), \$17,000
- Labor + Materials ~ \$5000
- Total \$22,000
- Need 1 or 2 of 160L LN2 bottle to fill every week (LN2~\$30, LAr~\$160)
- No need technician's help for operation

#### Test procedure

- 4 PMTs are simultaneously immersed in LN2
- 1 PMT (calibration PMT) stays same location during all tests
- PMTs are immersed in LN2 least 3 days with dark before any tests
- LED illumination + trigger in LN2 (no purity issue)



### 3. MicroBooNE PMT test stand

#### Open Dewar based PMT test stand

- Dark current and gain are measured both in air and liquid nitrogen (LN2).
- Operation HV values in cryogenic temperature are extracted.

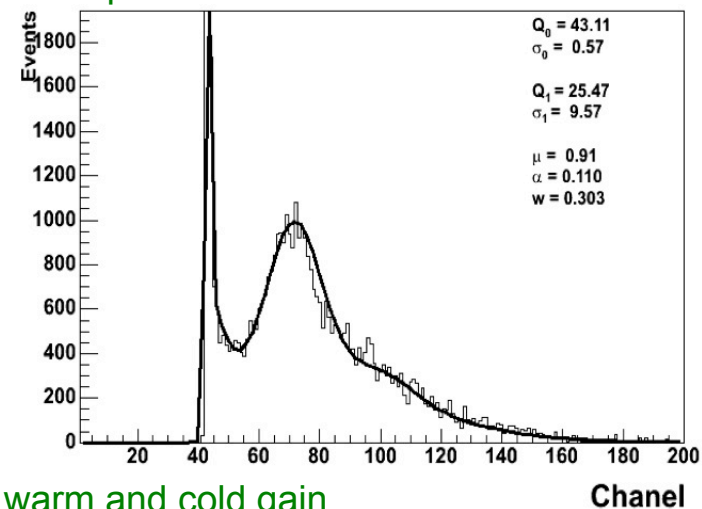

Typical warm and cold gain

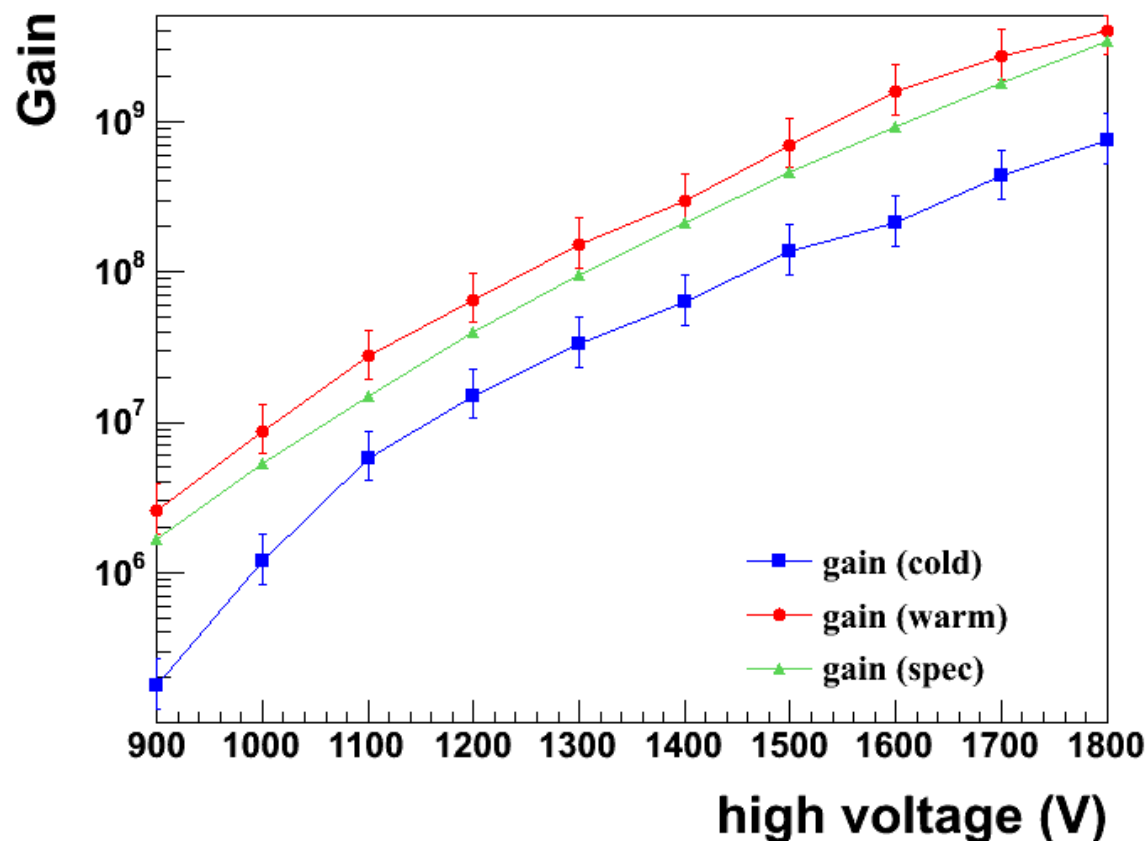

Gains are measured at every 100V from 900V to 1800V.

PMT cold gains are ~10-50% of warm gains.

Optimal HV value for  $3E7$  gain is extrapolated.

### 3. MicroBooNE PMT test stand

#### Open Dewar based PMT test stand

- Dark current and gain are measured both in air and liquid nitrogen (LN2).
- Operation HV values in cryogenic temperature are extracted.

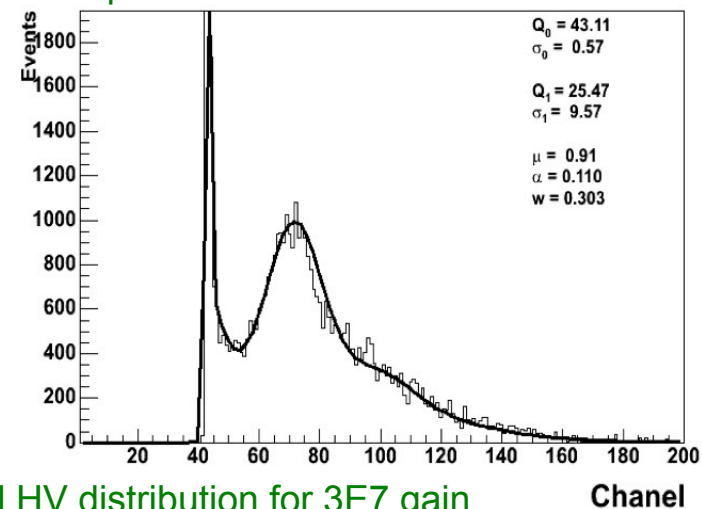

#### Optimal HV distribution for 3E7 gain

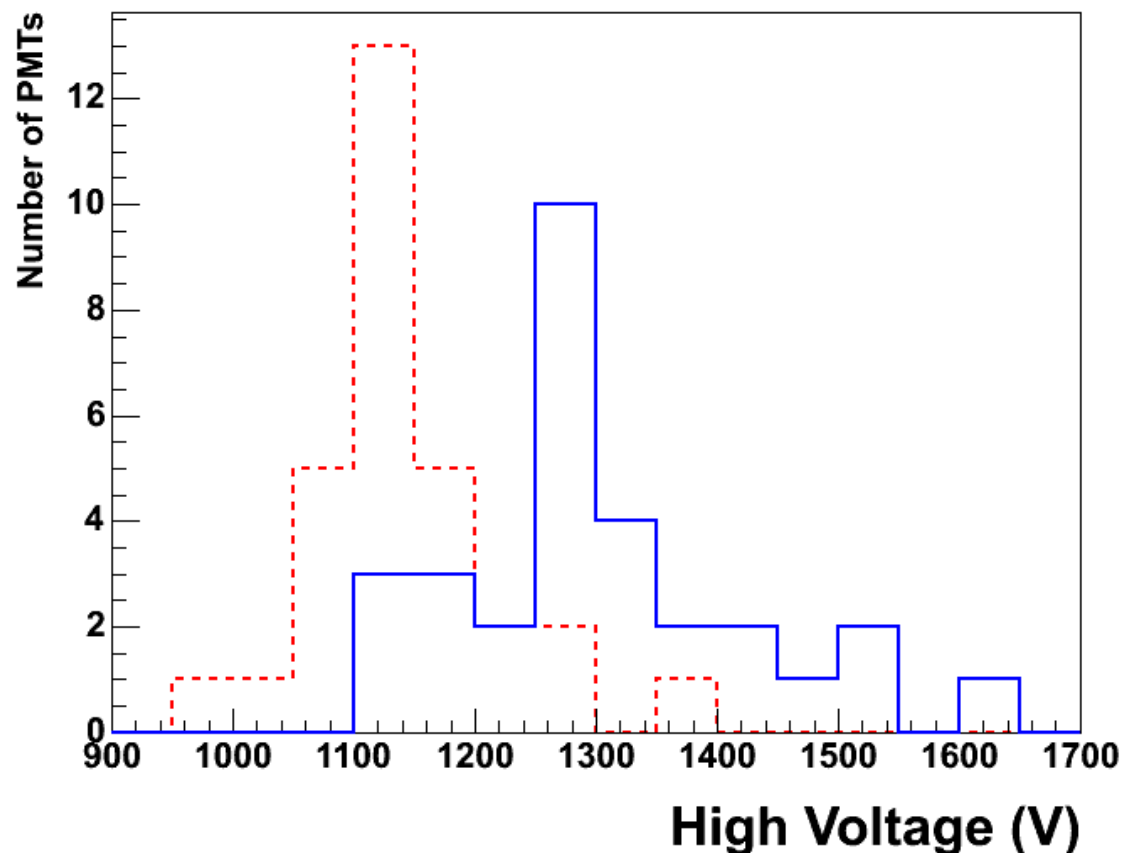

Gains are measured at every 100V from 900V to 1800V.

PMT cold gains are ~10-50% of warm gains.

Optimal HV value for 3E7 gain is extrapolated.

~200 V increase can recover gain drop

### 3. MicroBooNE PMT test stand

#### Open Dewar based PMT test stand

- Dark current and gain are measured both in air and liquid nitrogen (LN2).
- Operation HV values in cryogenic temperature are extracted.

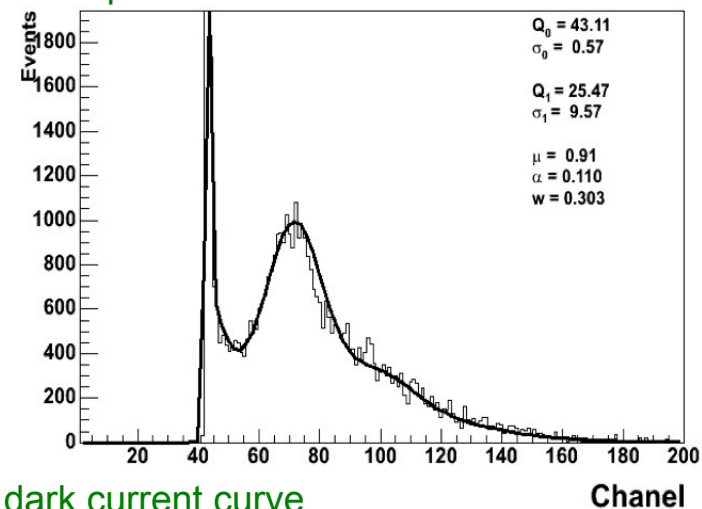

Cold dark current is slightly higher than warm dark current.

Cold noise doesn't show "plateau break down" at higher HV.

These results are not intuitive, but in fact well known.

NIMA621(2010)437

JINST2(2007)P11004

ArXiv:0805.0771

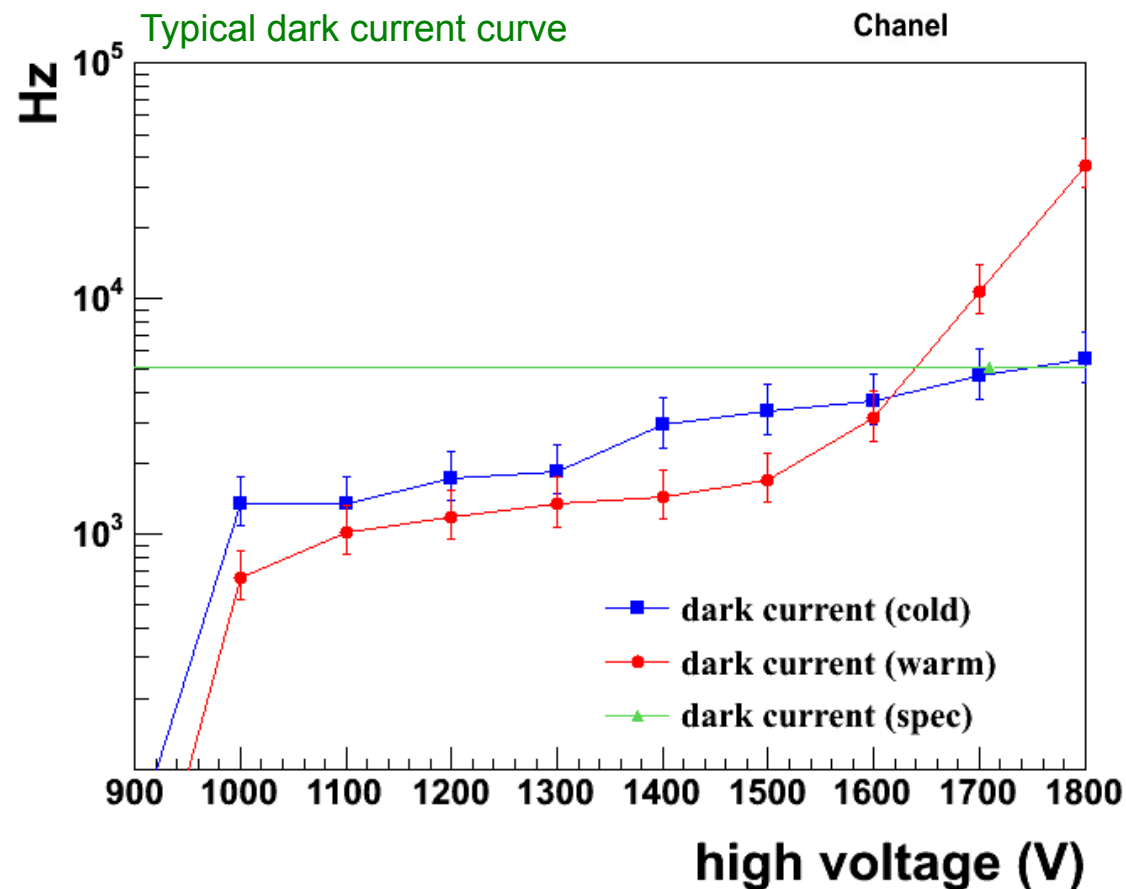

### 3. MicroBooNE PMT unit

32 PMTs with 4 light guides

- PMT sits in spring-loaded structure
- avoid direct glass-metal contact by teflon
- cryogenic magnetic shield

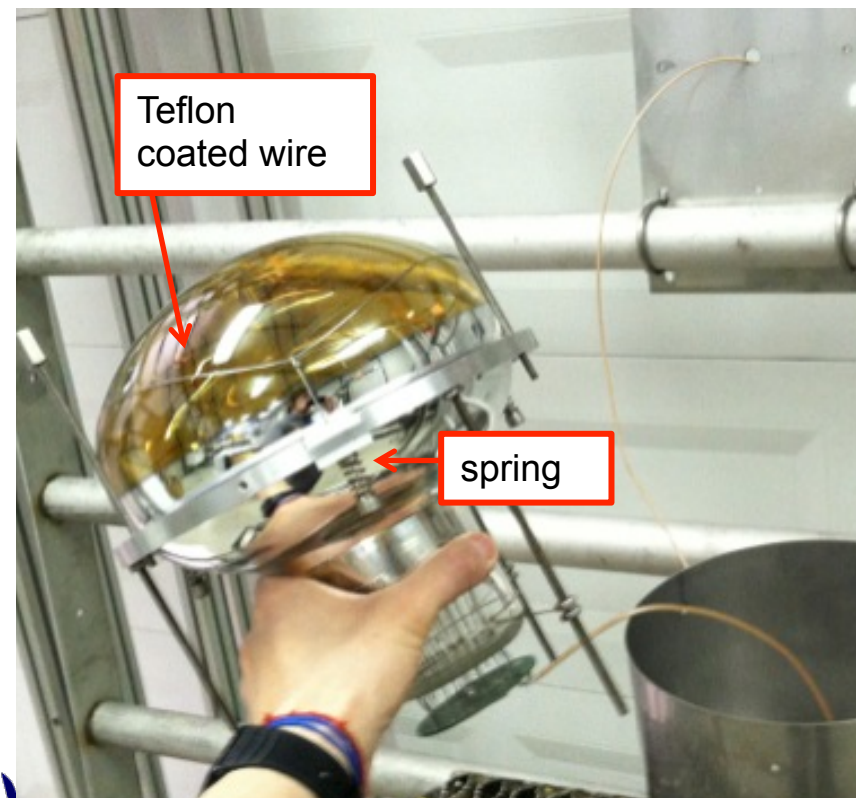
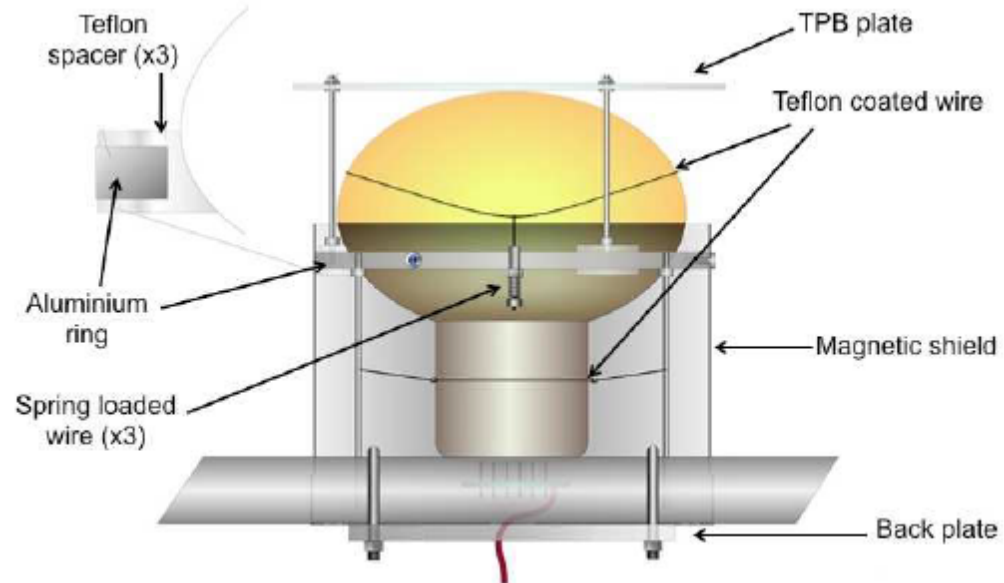

### 3. MicroBooNE PMT unit

32 PMTs with 4 light guides

- PMT sits in spring-loaded structure
- avoid direct glass-metal contact by teflon
- cryogenic magnetic shield

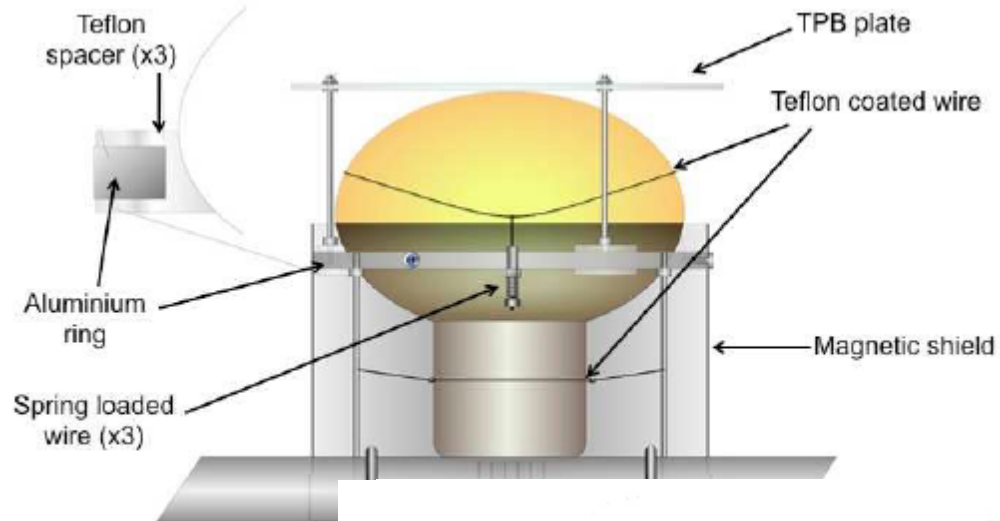

MicriBooNE PMT rotator

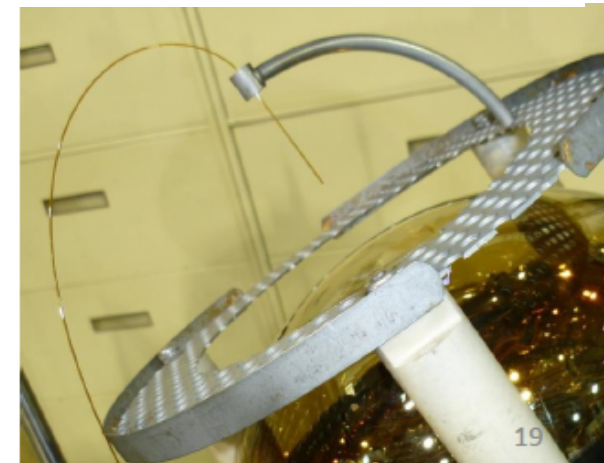
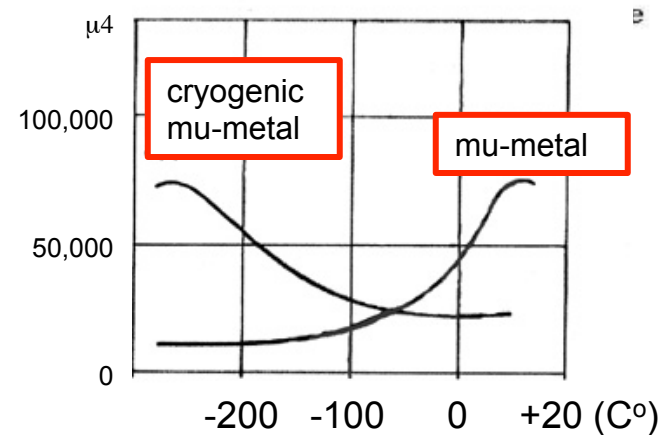
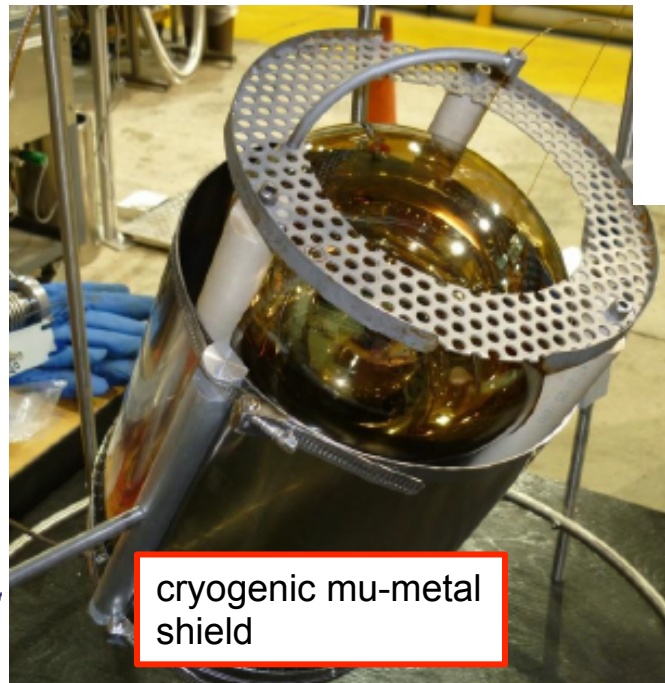
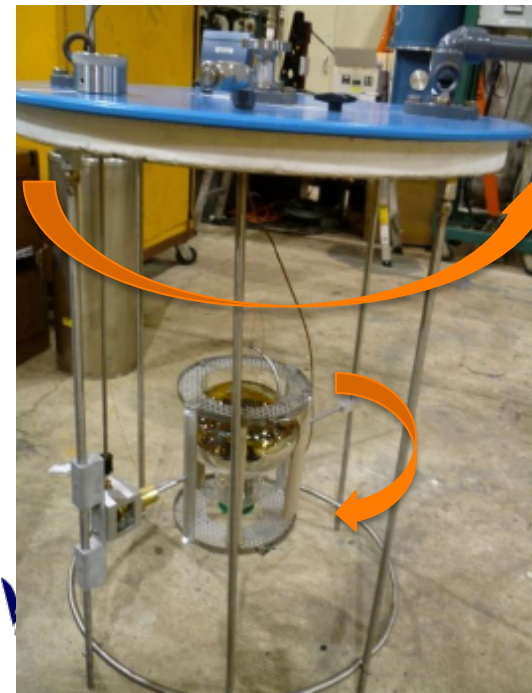

### 3. MicroBooNE PMT unit

32 PMTs with 4 light guides

- PMT sits in spring-loaded structure
- avoid direct glass-metal contact by teflon
- cryogenic magnetic shield

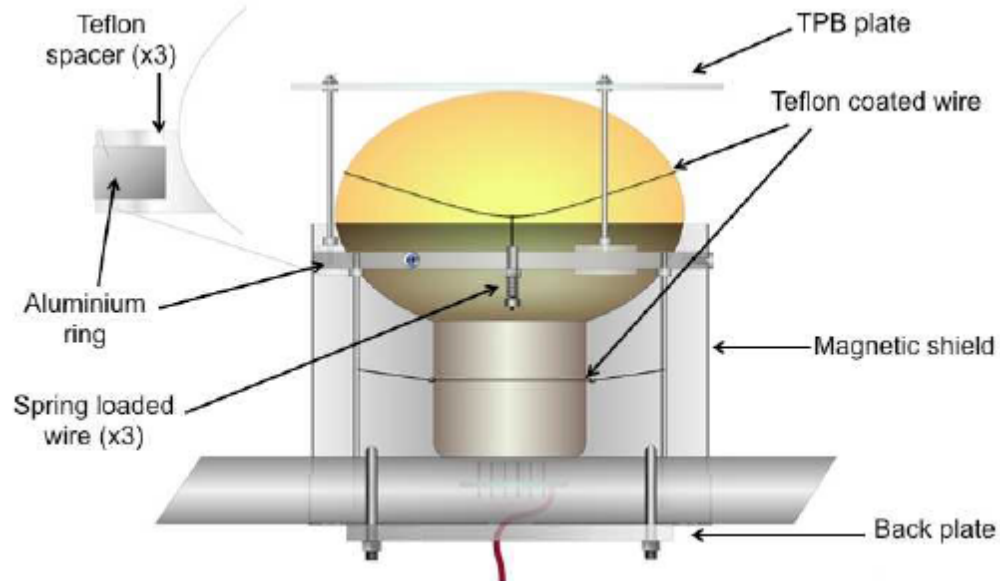
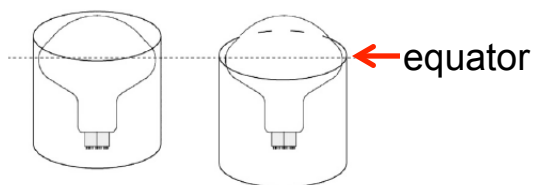

**fractional deviation from mean Q vs. angle, liquid nitrogen**

Relative signal variation with PMT angle

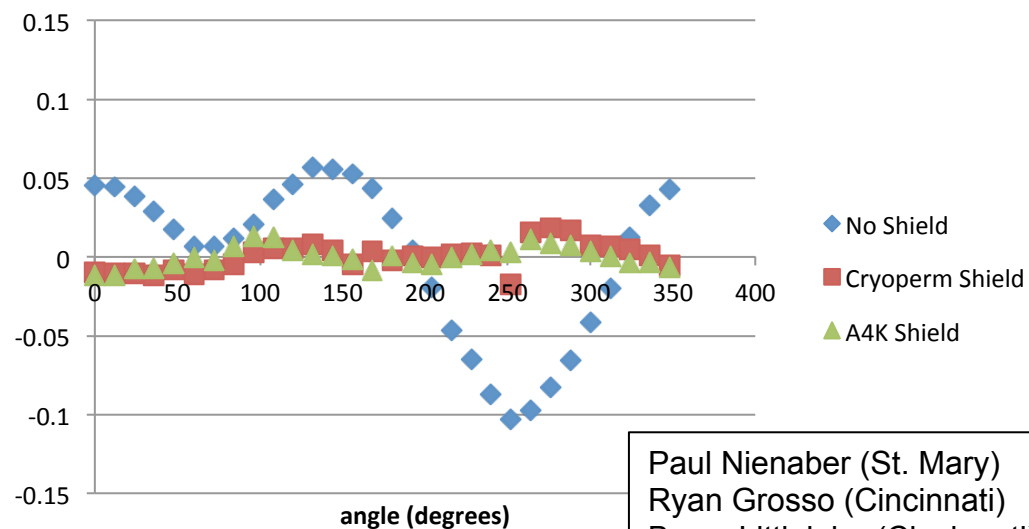
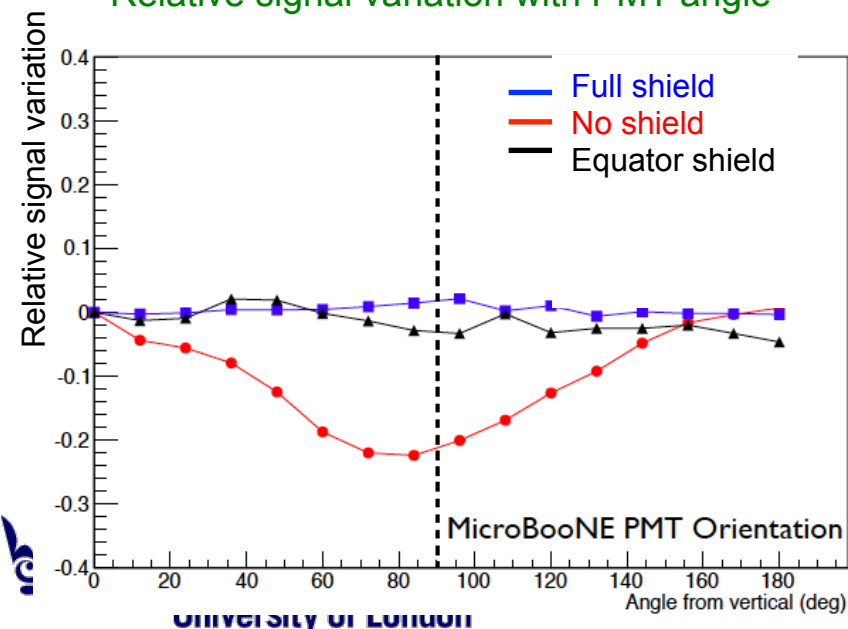

Paul Nienaber (St. Mary)  
Ryan Grosso (Cincinnati)  
Bryce Littlejohn (Cincinnati)

### 3. MicroBooNE PMT array system

#### 32 PMTs with 4 light guides

- PMT sits in spring-loaded structure
- avoid direct glass-metal contact by teflon
- cryogenic magnetic shield

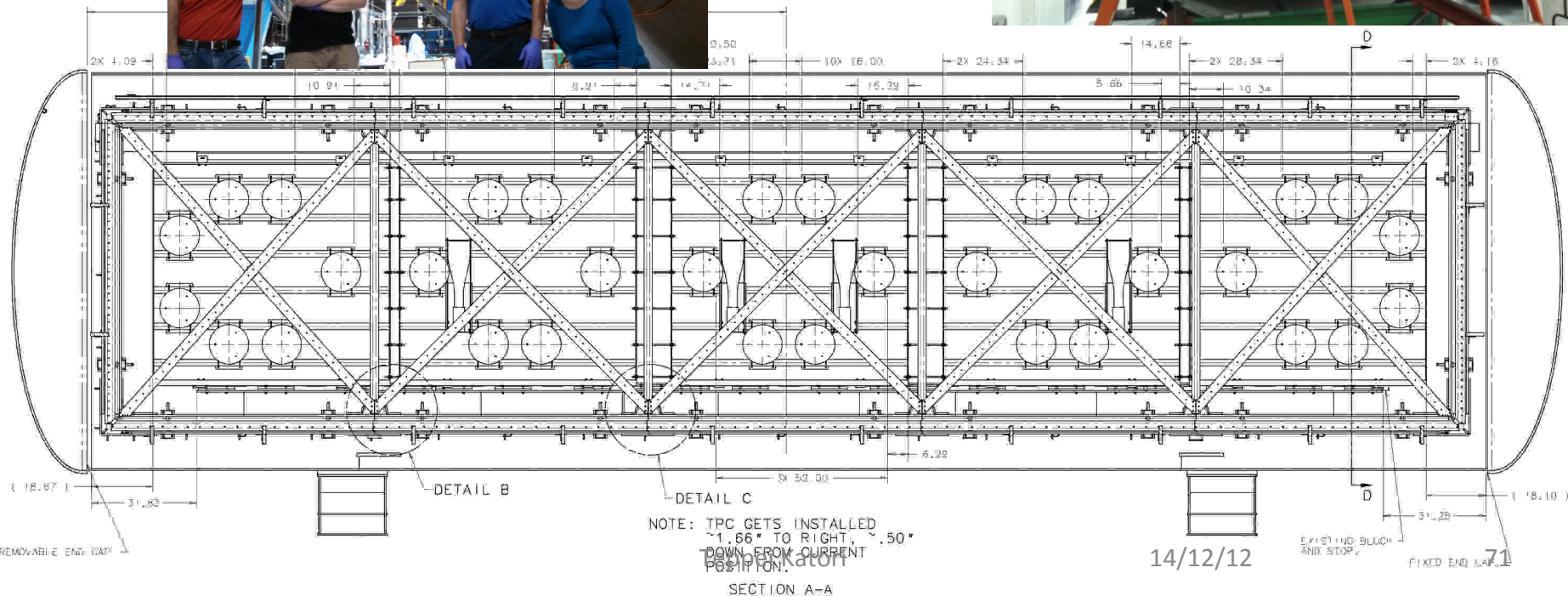
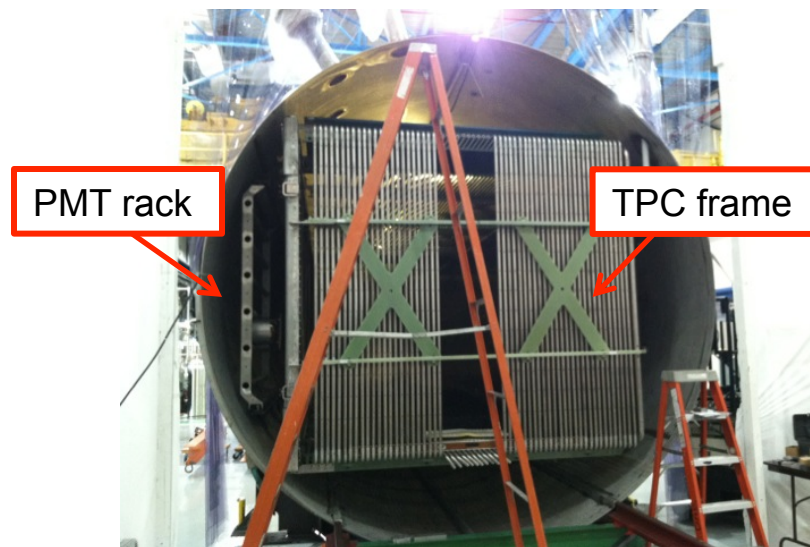

### 3. Light guide

#### TPB coated acrylic bar

- TPB re-emitted light is trapped in acrylic bar, and internally reflect
- Collected by photo-sensor (2-inch PMT) at the end
- The concept works, efficiency seems low
- MicroBooNE has 4 of them to compare performance with 8-inch PMTs

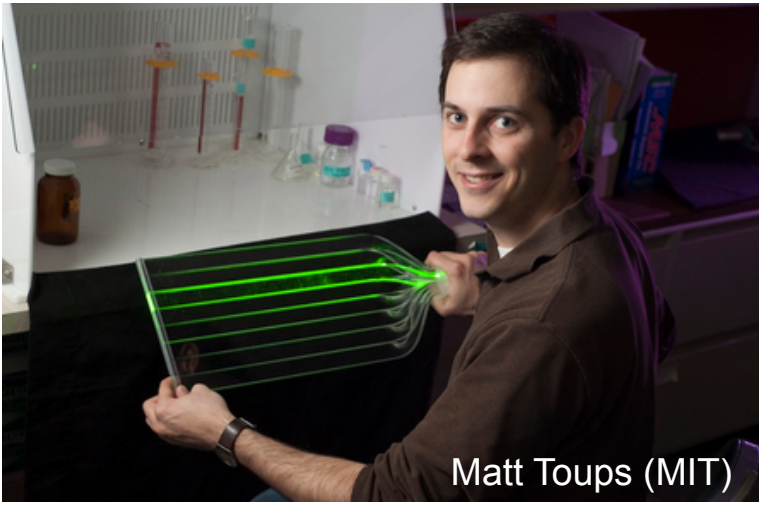

LBNE APA concept  
Anode Plane Assembly  
conceptual design. Wires  
are wrapping around a light  
guide

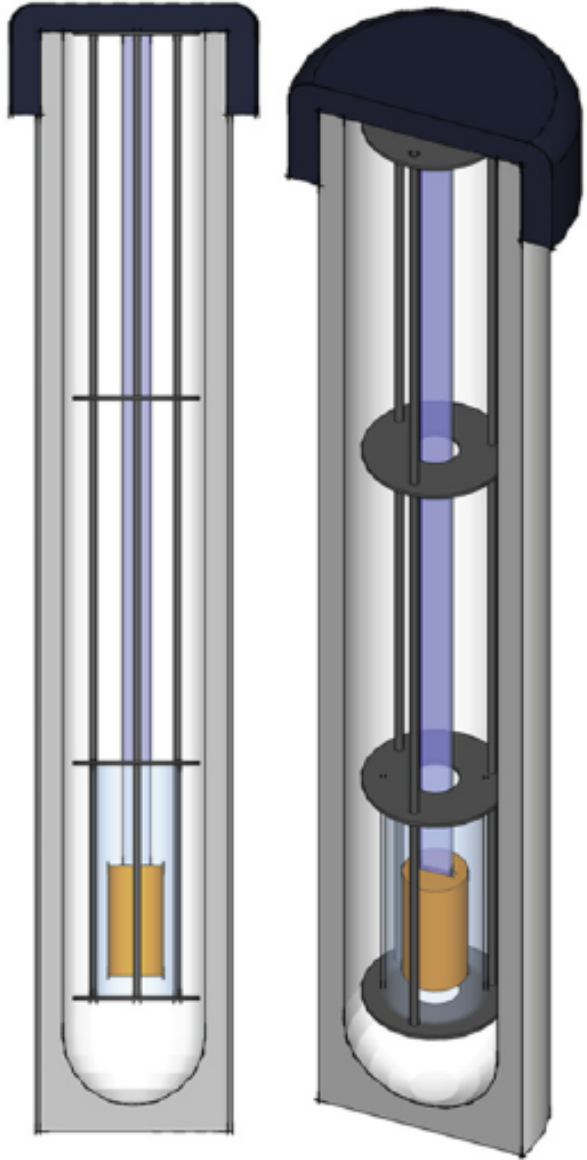
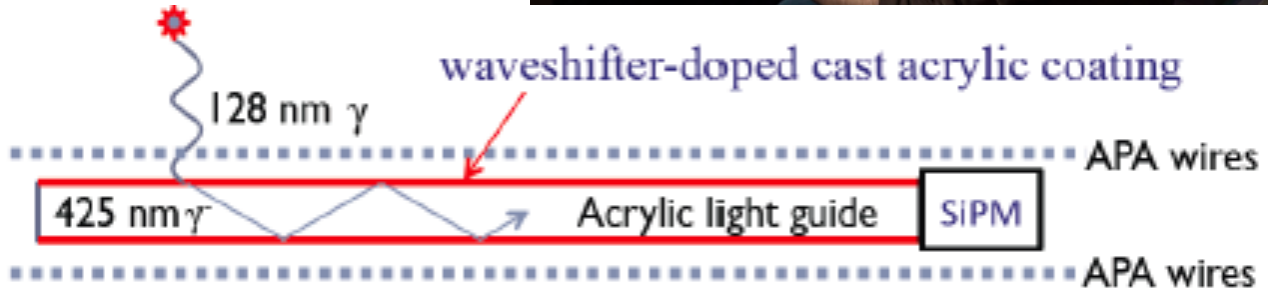



## 3. Light guide

### TPB coated acrylic bar

- TPB re-emitted light is trapped in acrylic bar, and internally reflect
- Collected by photo-sensor (2-inch PMT) at the end
- The concept works, efficiency seems low
- MicroBooNE has 4 of them to compare performance with 8-inch PMTs

### Initial light guide test results

- The basic idea works
- Efficiency is rather low ( $\sim 0.1\%$ )
- Lots of room to improve
  - better quality of acrylic
  - better TPB deposition technique

### Long Bo

- Indiana university further improved this technique, and tested

### LBNE35ton

- It will equipped one of these

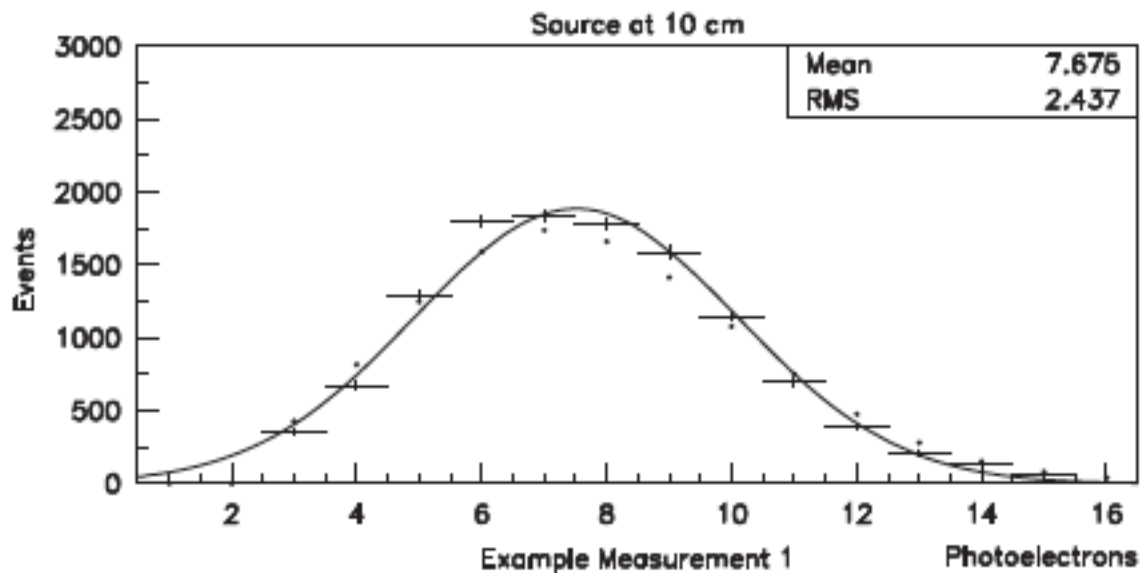

## 3. LAr light collection group

1. The Effects of Dissolved Methane upon Liquid Argon Scintillation Light  
Ben Jones et al., (JINST 8 (2013) P12015)
2. A Measurement of the Absorption of LAr Scintillation Light by Dissolved N<sub>2</sub> at the Part-Per-Million Level  
Ben Jones et al., (JINST 8 (2013) P07011)
3. Testing of Cryogenic Photomultiplier Tubes for the MicroBooNE Experiment  
Briese et al., (JINST 8 (2013) T07005)
4. Photodegradation Mechanisms of Tetraphenyl Butadiene Coatings for Liquid Argon Detectors  
Ben Jones et al., (JINST 8 (2013) P01013)
5. Benchmarking TPB-coated Light Guides for Liquid Argon TPC Light Detection Systems  
B. Baptista et al., (e-Print: arXiv:1210.3793 [physics.ins-det])
6. Environmental Effects on TPB Wavelength-Shifting Coatings  
C. Chiu et al., (JINST 7 (2012) P07007)
7. Demonstration of a Lightguide Detector for Liquid Argon TPCs  
L. Bugel et al., (Nucl.Instrum.Meth. A640 (2011) 69-75)

and more..., Liquid argon is the home of R&D papers!

1. Introduction
2. US LArTPC programs
3. LAr photon detection R&D
- 4. Challenge of LArTPC technology**
5. Conclusion

## 4. Challenge of LArTPC technology

### Cosmic rays

- Cosmic rays of MicroBooNE is  $\sim 10\text{kHz}$
- MicroBooNE DAQ windows is  $\sim 1.6\text{ ms}$
- $\sim 20$  cosmic rays across the detector in the DAQ window
- Reconstruction program needs to find true neutrino interaction and tracks successfully
- Combination of PMT and TPC information can find all cosmic rays efficiently

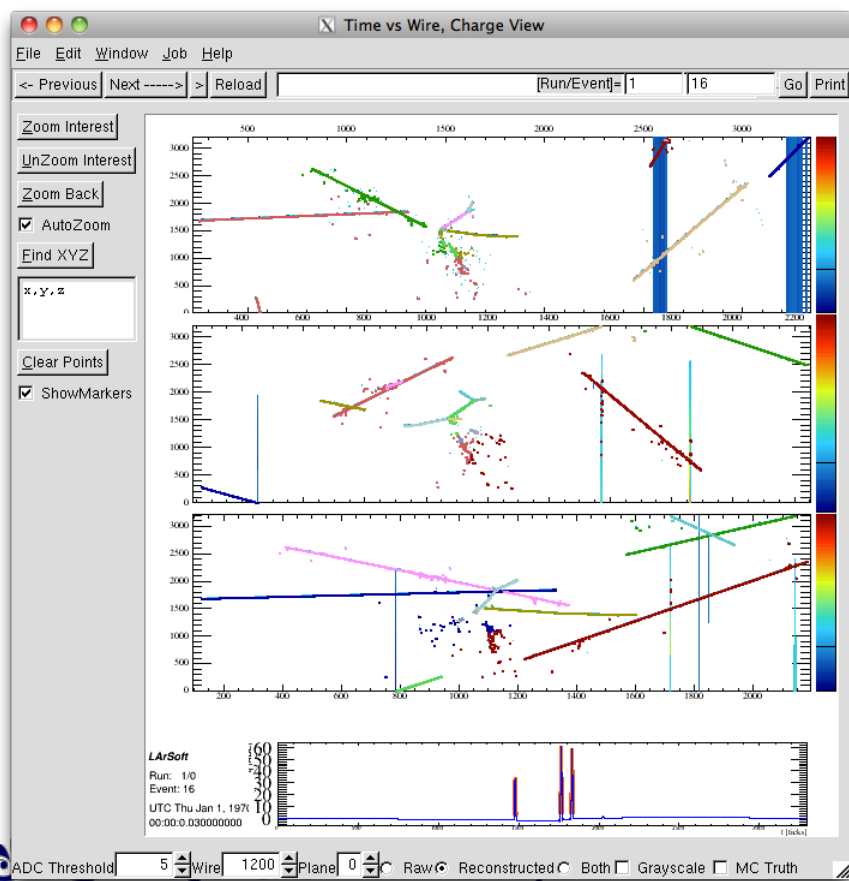

Simulated MicroBooNE event, reconstructed in 3D

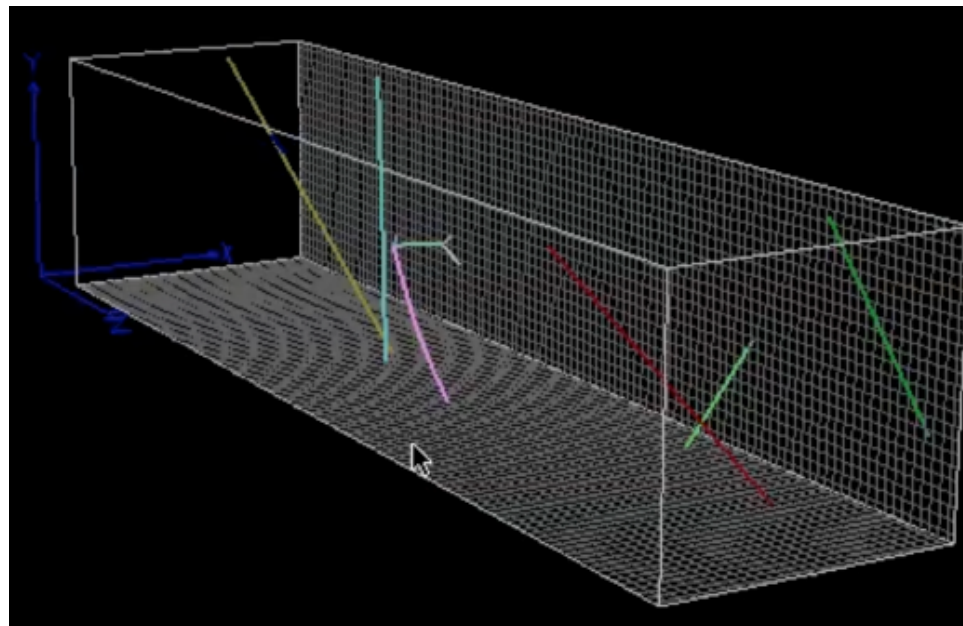

## 4. Challenge of LArTPC technology

### Positive ion problem

- Cosmic rays of MicroBooNE is  $\sim 10\text{kHz}$
- They produce tons of argon ions
- Speed of argon ions ( $\sim \text{cm/s}$ )  $<$  liquid argon flows
- Vortex of liquid argon flow behave like a “sink” of positive ions
- Electric field inside of the TPC is never straight

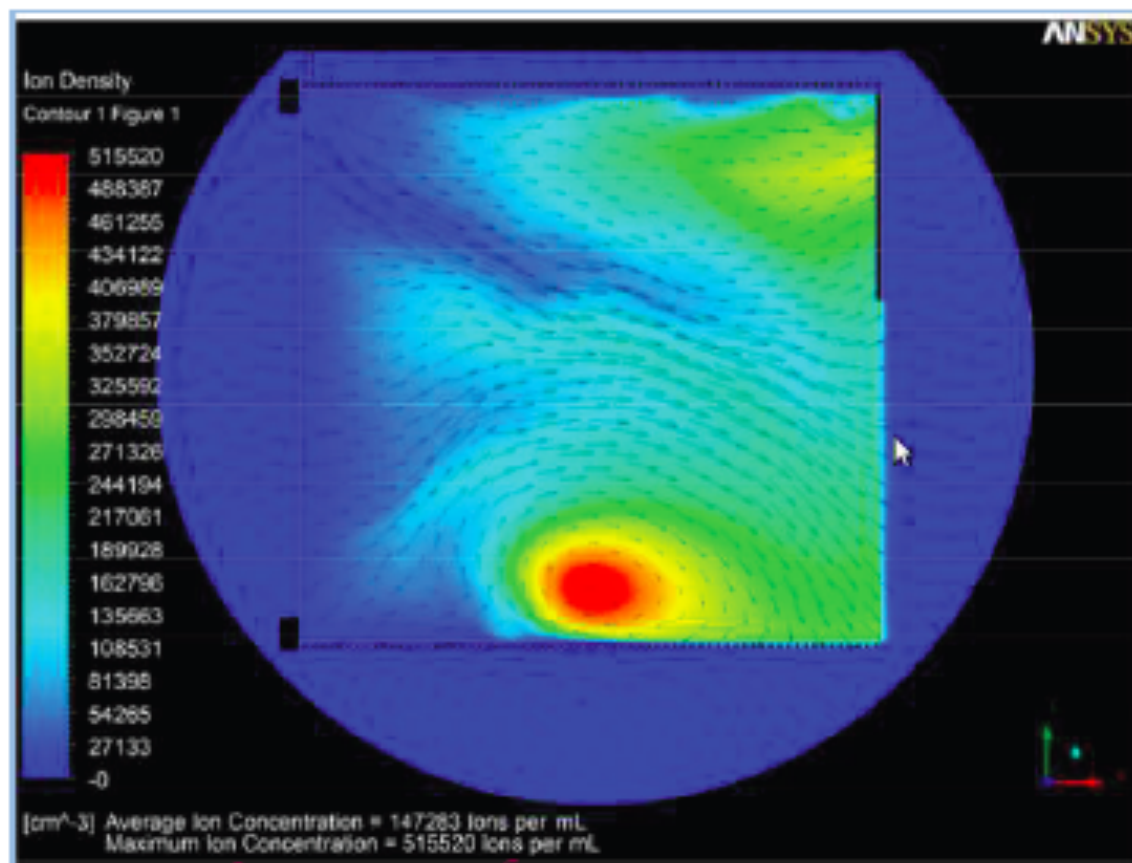

## 4. Challenge of LArTPC technology

### Positive ion problem

- Cosmic rays of MicroBooNE is  $\sim 10\text{kHz}$
- They produce tons of argon ions
- Speed of argon ions ( $\sim \text{cm/s}$ )  $<$  liquid argon flows
- Vortex of liquid argon flow behave like a “sink” of positive ions
- Electric field inside of the TPC is never straight

### Con – ICARUS surface running

- ICARUS took cosmic ray data on surface, and it shows perfect parallel lines of comic rays, showing electric field is uniform across the detector
- ICARUS and MicroBooNE has different cryostat, cooling, flow system, etc

To manage field distortion, MicroBooNE has a laser calibration system.

We will find out this effect from MicroBooNE data

How about LBNE?

## 4. Challenge of LArTPC technology

### High voltage system

- MicroBooNE need to drift 2.5m
- Drift velocity is chosen to be same with ICARUS (1.5m/ms)
- It requires 500V/cm → 125kV total
- It sounds easy if we trust what textbook said...

Table 3.3 Maximum breakdown strengths of some liquids

Liquid	Maximum breakdown strength (MV/cm)
Hexane	1.1–1.3
Benzene	1.1
Transformer oil	1.0
Silicone	1.0–1.2
Liquid Oxygen	2.4
Liquid Nitrogen	1.6–1.9
Liquid Hydrogen	1.0
Liquid Helium	0.7
Liquid Argon	1.10–1.42

## 4. Challenge of LArTPC technology

### High voltage system

- MicroBooNE need to drift 2.5m
- Drift velocity is chosen to be same with ICARUS (1.5m/ms)
- It requires 500V/cm → 125kV total
- It sounds easy if we trust what textbook said...

MicroBooNE prototype feed-through has a hard time to send 125kV, details of HV break down may depend on many factors (shape and material of feed-through, for example).

if we cannot send 125 kV, MicroBooNE need to run with lower voltage than designed (500V/cm → ?)

- longer drift time (larger DAQ window)
- more cosmic rays in beam window
- more positive ion effect
- more diffusions (worse resolution)
- more recombination (less ionization signal)

MicroBooNE R&D on this topic is critical for future LArTPCs.



# 4. Challenge of LArTPC technology

## Reconstruction

- Event topology is extremely richer than any existing neutrino detectors
- Reconstruction is not easy, sensitivity study is based on MC truth or MC truth with simulated detector effect (called fast MC), to avoid reconstruction
- Otherwise, efficiency is estimated from hand scan

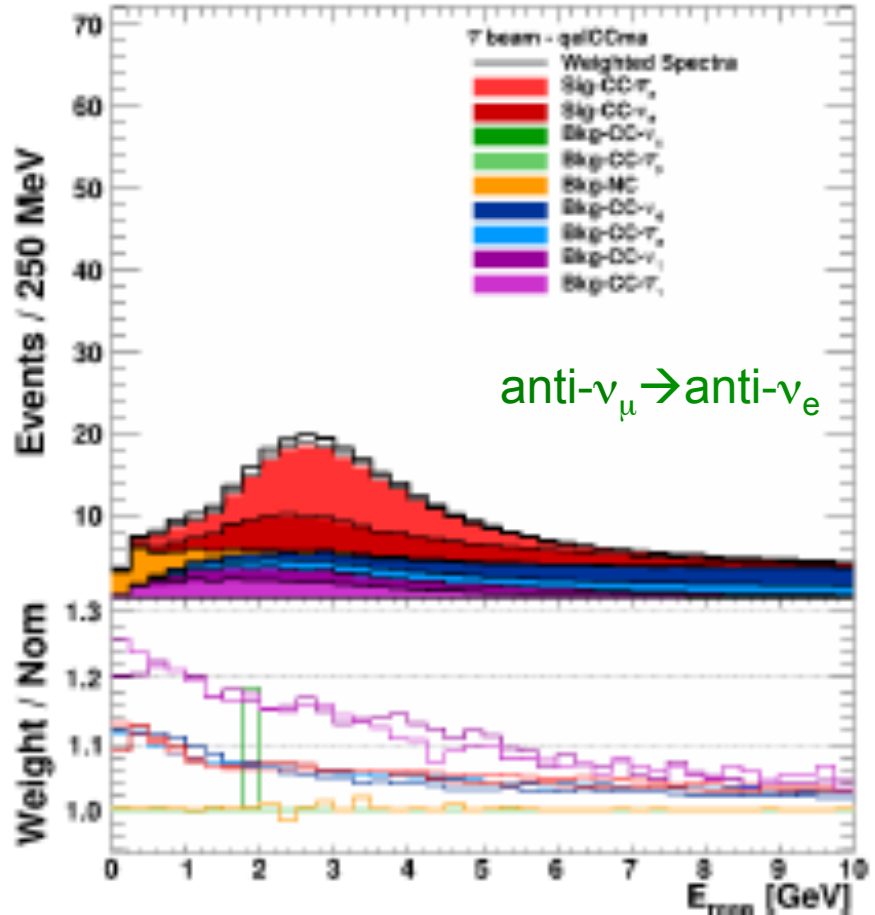
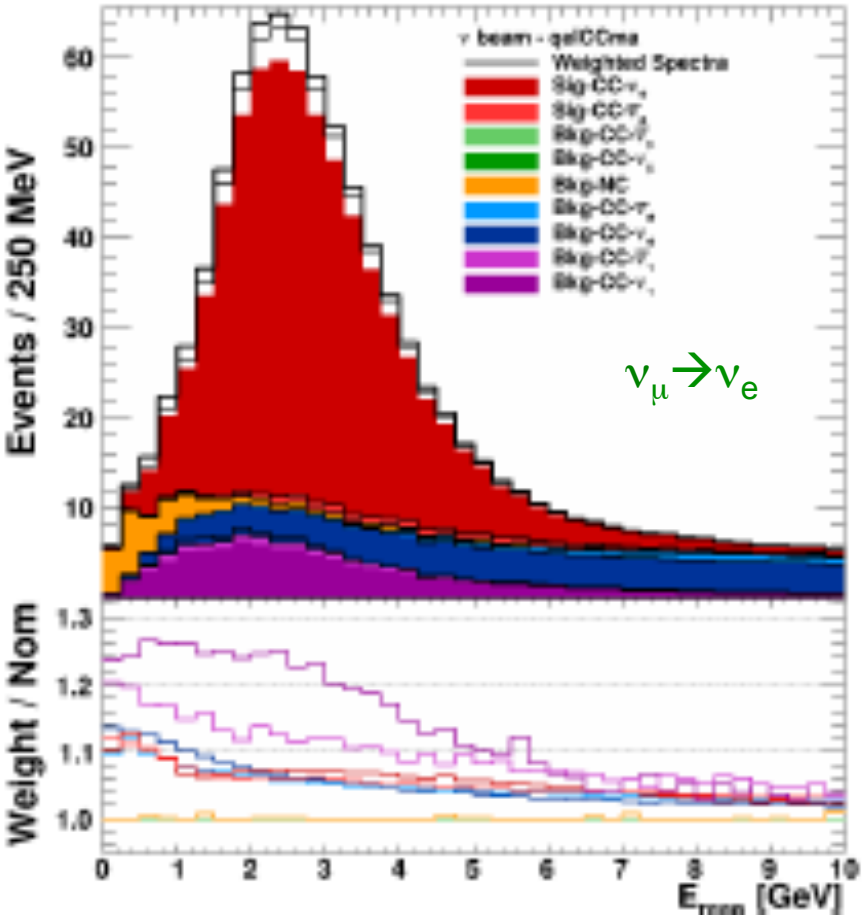

## 4. Challenge of LArTPC technology

### No nuclear model

- In this energy region (<few GeV), nuclear effect is important.
- Argon nucleus is too big to calculate precisely. The best ab initio nuclear model is available only up to  $^{12}\text{C}$ .
- Nuclear model is up to phenomenological one.

MicroBooNE should be able to test these phenomenological models, to reduce errors for future experiments.

## 4. Challenge of LArTPC technology



### NuSTEC (Neutrino scattering Theory-Experiment Collaboration)

NuSTEC is a collaboration of experimentalists and theorists whose mission is to improve neutrino interaction generators, organize workshops to answer community challenges as well as training programs in neutrino nucleus scattering physics and to initiate a global fit of combined results from multiple experiments to theoretical models.

#### NuSTEC training in neutrino-nucleus scattering physics

##### Organizing committee

**Luiz Alvarez-Ruso\*** (Valencia, Spain), Constantinos Andreopoulos (Liverpool/RAL, UK), Omar Benhar (Rome Sapienza/INFN, Italy), Yoshinari Hayato (ICRR/University of Tokyo, Japan), Teppei Katori (Queen Mary University of London, UK), **Camillo Mariani\*** (Virginia Tech, USA), **Jorge Morfin\*** (Fermilab, USA), Ulrich Mosel (University of Giessen, Germany), Ornella Palamara (Yale University, USA), Makoto Sakuda (Okayama University, Japan), Rocco Schiavilla (JLAB/Old Dominion University, USA), Jan Sobczyk (Wroclaw University, Poland), Martin Tzanov (Louisiana State University, USA), Sam Zeller (Fermilab, USA) \* **co-chairs**

## 4. Challenge of LArTPC technology



### NuSTEC (Neutrino scattering Theory-Experiment Collaboration)

NuSTEC is a collaboration of experimentalists and theorists whose mission is to improve neutrino interaction generators, organize workshops to answer community challenges as well as training programs in neutrino nucleus scattering physics and to initiate a global fit of combined results from multiple experiments to theoretical models.

### NuSTEC Training in Neutrino-Nucleus Scattering Physics (aka NuSTEC school)

- One and only on school specialized for neutrino cross-section

Oct. 21-29, 2014, Fermilab

~ 80 participants (PhD students, postdocs)

~ half theorists, half experimentalists



## 4. Challenge of LArTPC technology



### NuSTEC (Neutrino scattering Theory-Experiment Collaboration)

NuSTEC is a collaboration of experimentalists and theorists whose mission is to improve neutrino interaction generators, organize workshops to answer community challenges as well as training programs in neutrino nucleus scattering physics and to initiate a global fit of combined results from multiple experiments to theoretical models.

### NuSTEC Training in Neutrino-Nucleus Scattering Physics (aka NuSTEC school)

- One and only on school specialized for neutrino cross-section

NuSTEC school 2015 - Nov. 9 – 13, 2015, Okayama, Japan

NuInt 15 - Nov. 16-20, 2015, Osaka, Japan

Sign up “neutrino cross-section newsletter”!  
(go google, type “neutrino cross section newsletter”)  
<https://pprc.qmul.ac.uk/~katori/nu-xsec.html>

## Conclusion

LArTPC technology is initiated by ICARUS, and now flourish in US

There are number of projects actively studying LArTPC

MicroBooNE is up coming neutrino beam experiment with LArTPC

All effort focus to the future large LArTPC, such as LBNE

**Thank you for your attention!**